

Echelon Plus[®]



ORNAMENTAL ALUMINUM FENCE

Echelon Plus has taken the *quality and performance* of aluminum ornamental fencing to a higher level. The strength characteristics of the *reinforced rail and posts*, coupled with a *superior powder coat finish* make Echelon Plus the *most durable .75" ornamental picket product on the market*.

PRIMARY APPLICATIONS

- ▶ ***Municipal Facilities***
- ▶ ***Childcare Facilities***
- ▶ ***Coastal Environments***
- ▶ ***Parks & Recreation***
- ▶ ***Schools***



AMERISTARFENCE.COM | 888-333-3422

ASSA ABLOY, the global leader in door opening solutions

AMERISTAR[®]

ASSA ABLOY

Echelon Plus®

ORNAMENTAL ALUMINIUM FENCE

.75"sq x .045" wall PICKETS | 1.4375" x 1.25" x (.090" side / .060" top) ForeRunner™ RAILS
2.5"sq x .060" POSTS w/reinforced internal web

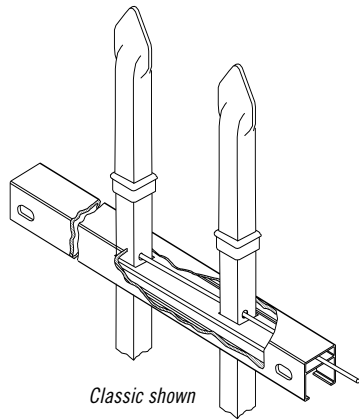

STYLE OPTIONS

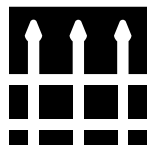

CLASSIC™

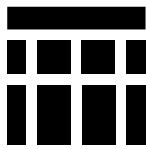

MAJESTIC™

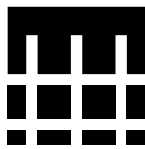

GENESIS™

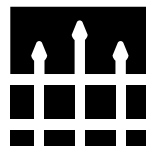

WARRIOR™

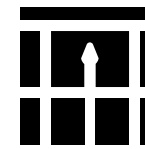

CONQUORER™



FABRICATION & DESIGN

Ameristar crafted the ForeRunner rail to increase strength through architecture. The innovative design of the ForeRunner rail contains an internally secured rod that allows for variable pitch connection, high angle biasability and is easy to install. Internal security eliminates the need for visually unappealing external fasteners.



POWDERED COATED SUPERIOR FINISH

Echelon features a state of the art polyester powder coating system that provides a durable and scratch resistant finish. This eco-friendly process provides years of long-lasting durability and maintenance-free ownership.



LIFETIME LIMITED WARRANTY

The Echelon families of aluminum fencing products are manufactured from superior quality materials by skilled craftsmen with the highest standards of workmanship in the industry. Ameristar is confident in offering Echelon with a limited lifetime warranty, backed by over 30 years of demonstrated excellence in manufacturing of ornamental fence.



DOMESTIC MANUFACTURING

Ameristar is committed to providing products that are manufactured in the USA. We have made significant investments in technology, process improvement, and employee training in an effort to secure American jobs and combat inferior import products.



FENCE PRODUCTS

TO PLACE YOUR ORDER CALL 888-333-3422

VISIT AMERISTARFENCE.COM

ECHELON PLUS® | 2, 3 & 4-RAIL OPTIONS | 4" AIR-SPACE

STANDARD BOTTOM & FLUSH BOTTOM OPTIONS AVAILABLE

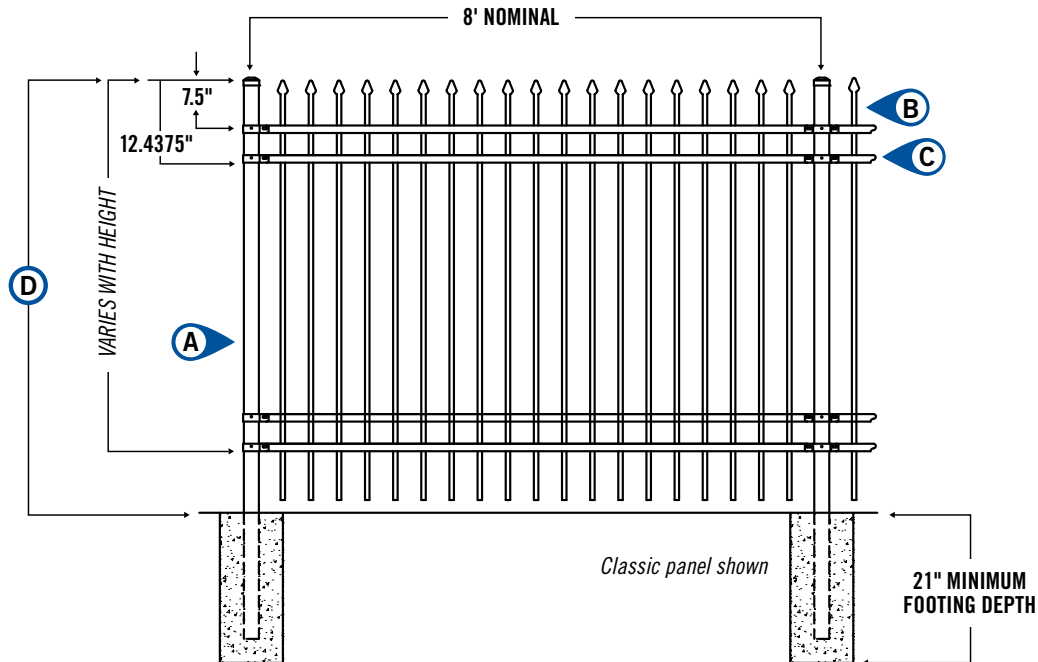

- Ⓐ 2.5"sq x .060" POSTS (with reinforced internal web)
- Ⓑ .75"sq x 0.045" wall PICKETS
- Ⓒ 1.4375"w x 1.25"h (0.090" side / 0.060" top) ForeRunner RAILS
- Ⓓ 3', 3½', 4', 4½', 5' & 6' PANEL HEIGHTS

PANELS REQUIRE ASSEMBLY

Refer to construction specification & tables within this section for recommended post space by bracket type

Effective: 01/06/15

ECHELON PLUS® | 3-RAIL PANELS | 4" AIR SPACE

STANDARD BOTTOM | 8' PANEL LENGTH (91.75" actual width) | 19 PICKETS PER PANEL

PANEL	ITEM NUMBER	WEIGHT	STOCKING
3'	A☒⊗3368	21 lbs	⊙
3½'	A☒⊗3428	23 lbs	⊙
4'	A☒⊗3488	24 lbs	CB MB GB WB RB
5'	A☒⊗3608	27 lbs	CB MB GB WB RB
6'	A☒⊗3728	30 lbs	⊙

☒ = FENCE STYLES AVAILABLE | **C** = Classic **M** = Majestic **G** = Genesis
W = Warrior **R** = Conqueror

⊗ = COLOR OPTIONS AVAILABLE | **B** = Black **N** = Bronze **W** = White

⊙ = NON-STOCKED PRODUCT
 For details, see Ameristar's Sales Policy in the catalog guide.

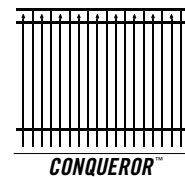
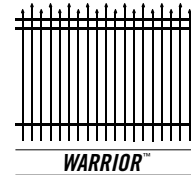
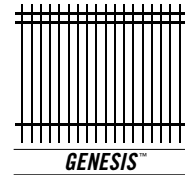
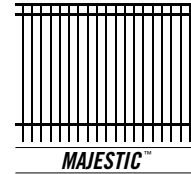
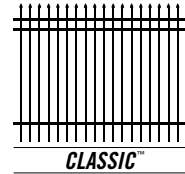

ECHELON PLUS® | 3-RAIL PANELS | 4" AIR SPACE

FLUSH BOTTOM | 8' PANEL LENGTH (91.75" actual width) | 19 PICKETS PER PANEL

PANEL	ITEM NUMBER	WEIGHT	STOCKING
3'	A☒⊗3368F	21 lbs	⊙
3½'	A☒⊗3428F	23 lbs	⊙
4'	A☒⊗3488F	24 lbs	⊙
5'	A☒⊗3608F	27 lbs	⊙
6'	A☒⊗3728F	30 lbs	⊙

☒ = FENCE STYLES AVAILABLE | **C** = Classic **M** = Majestic **G** = Genesis
W = Warrior **R** = Conqueror

⊗ = COLOR OPTIONS AVAILABLE | **B** = Black **N** = Bronze **W** = White

⊙ = NON-STOCKED PRODUCT
 For details, see Ameristar's Sales Policy in the catalog guide.

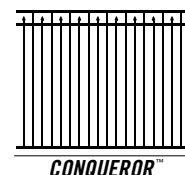
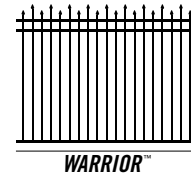
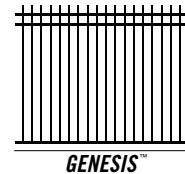
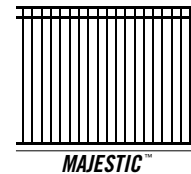
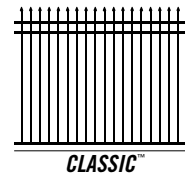

Effective: 01/06/15

ECHELON PLUS® | 3-RAIL PANELS WITH RINGS | 4" AIR SPACE

STANDARD BOTTOM | 8' PANEL LENGTH (91.75" actual width) | 19 PICKETS PER PANEL

PANEL	ITEM NUMBER	WEIGHT	STOCKING
4'	A☒ⓧ3488R	29 lbs	☉
5'	A☒ⓧ3608R	32 lbs	☉

☒ = FENCE STYLES AVAILABLE | **C** = Classic **M** = Majestic **G** = Genesis **W** = Warrior

ⓧ = COLOR OPTIONS AVAILABLE | **B** = Black **N** = Bronze **W** = White

☉ = NON-STOCKED PRODUCT

For details, see Ameristar's Sales Policy in the catalog guide.

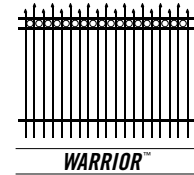
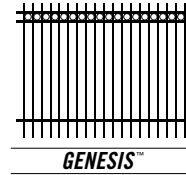
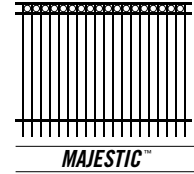
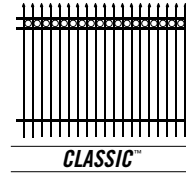

Effective: 01/06/15

ECHELON PLUS® | 4-RAIL PANELS | 4" AIR SPACE

STANDARD BOTTOM | 8' PANEL LENGTH (91.75" actual width) | 19 PICKETS PER PANEL

PANEL	ITEM NUMBER	WEIGHT	STOCKING
4'	A☒⊗4488	29 lbs	⊙
5'	A☒⊗4608	32 lbs	⊙
6'	A☒⊗4728	34 lbs	CB MB

☒ = FENCE STYLES AVAILABLE | **C** = Classic **M** = Majestic **G** = Genesis
W = Warrior **R** = Conqueror

⊗ = COLOR OPTIONS AVAILABLE | **B** = Black **N** = Bronze **W** = White

⊙ = NON-STOCKED PRODUCT

For details, see Ameristar's Sales Policy in the catalog guide.

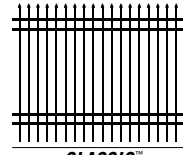

CLASSIC™

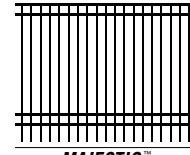

MAJESTIC™

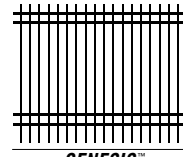

GENESIS™

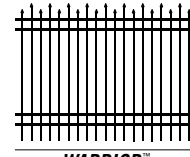

WARRIOR™

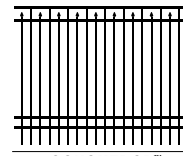

CONQUEROR™

ECHELON PLUS® | 4-RAIL PANELS | 4" AIR SPACE

FLUSH BOTTOM | 8' PANEL LENGTH (91.75" actual width) | 19 PICKETS PER PANEL

PANEL	ITEM NUMBER	WEIGHT	STOCKING
4'	A☒⊗4488F	29 lbs	⊙
5'	A☒⊗4608F	32 lbs	⊙
6'	A☒⊗4728F	34 lbs	⊙

☒ = FENCE STYLES AVAILABLE | **C** = Classic **M** = Majestic **G** = Genesis
W = Warrior **R** = Conqueror

⊗ = COLOR OPTIONS AVAILABLE | **B** = Black **N** = Bronze **W** = White

⊙ = NON-STOCKED PRODUCT

For details, see Ameristar's Sales Policy in the catalog guide.

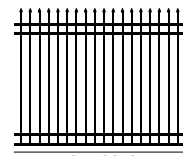

CLASSIC™

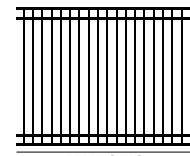

MAJESTIC™

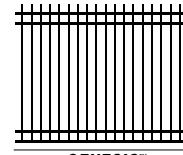

GENESIS™

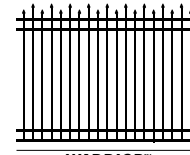

WARRIOR™

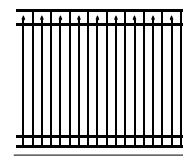

CONQUEROR™

Effective: 01/06/15

ECHELON PLUS® | 4-RAIL PANELS WITH RINGS | 4" AIR SPACE

STANDARD BOTTOM | 8' PANEL LENGTH (91.75" actual width) | 19 PICKETS PER PANEL

PANEL	ITEM NUMBER	WEIGHT	STOCKING
6'	A☒⊗4728R	39 lbs	⊙

☒ = FENCE STYLES AVAILABLE | **C** = Classic **M** = Majestic **G** = Genesis **W** = Warrior

⊗ = COLOR OPTIONS AVAILABLE | **B** = Black **N** = Bronze **W** = White

⊙ = NON-STOCKED PRODUCT

For details, see Ameristar's Sales Policy in the catalog guide.

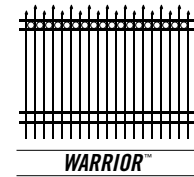
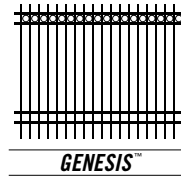
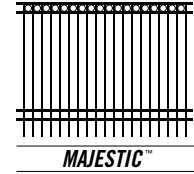
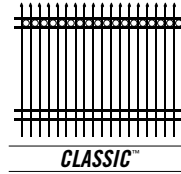

Effective: 01/06/15

ECHELON PLUS® | 2-RAIL POOL PANELS | 4" AIR SPACE

FLUSH BOTTOM | 6' PANEL LENGTH (73.0625" actual width) | 15 PICKETS PER PANEL

PANEL	ITEM NUMBER	WEIGHT	STOCKING
4' POOL	AM ⊗ 2486*	16 lbs	MB* MN*

- ☒ = FENCE STYLES AVAILABLE | **M** = Monarch*
 - ⊗ = COLOR OPTIONS AVAILABLE | **B** = Black **N** = Bronze **W** = White
 - ⊙ = NON-STOCKED PRODUCT
- For details, see Ameristar's Sales Policy in the catalog guide.*

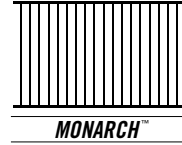

ECHELON PLUS® | 3-RAIL POOL PANELS | 4" AIR SPACE

FLUSH BOTTOM | 8' PANEL LENGTH (91.75" actual width) | 19 PICKETS PER PANEL

PANEL	ITEM NUMBER	WEIGHT	STOCKING
4½' POOL	A☒ ⊗ 3548	25 lbs	MB MN RB RN
4½' POOL	AM ⊗ 3548R	30 lbs	⊙

- ☒ = FENCE STYLES AVAILABLE | **M** = Majestic **R** = Conqueror
 - ⊗ = COLOR OPTIONS AVAILABLE | **B** = Black **N** = Bronze **W** = White
 - ⊙ = NON-STOCKED PRODUCT
- For details, see Ameristar's Sales Policy in the catalog guide.*

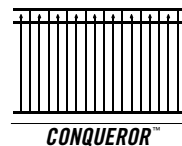
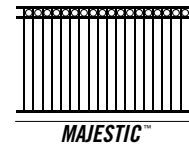
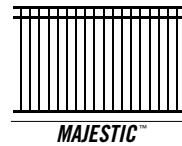

Effective: 01/06/15

ECHELON PLUS® | 3-RAIL PUPPY PANELS

STANDARD BOTTOM | 8' PANEL LENGTH (91.75" actual width) | 19 / 20† PICKETS PER PANEL

PANEL	ITEM NUMBER	WEIGHT	STOCKING
4'	A☒⊗3488D	35 lbs	☉
5'	A☒⊗3608D	38 lbs	☉

☒ = FENCE STYLES AVAILABLE | **C** = Classic **M** = Majestic **G** = Genesis

⊗ = COLOR OPTIONS AVAILABLE | **B** = Black **N** = Bronze **W** = White

☉ = NON-STOCKED PRODUCT

For details, see Ameristar's Sales Policy in the catalog guide.

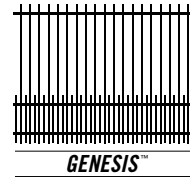
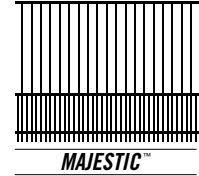
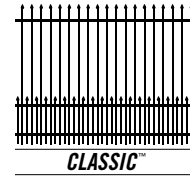

ECHELON PLUS® | 4-RAIL PUPPY PANELS

STANDARD BOTTOM | 8' PANEL LENGTH (91.75" actual width) | 19 / 20† PICKETS PER PANEL

PANEL	ITEM NUMBER	WEIGHT	STOCKING
6'	A☒⊗4728D	45 lbs	☉

☒ = FENCE STYLES AVAILABLE | **C** = Classic **M** = Majestic **G** = Genesis

⊗ = COLOR OPTIONS AVAILABLE | **B** = Black **N** = Bronze **W** = White

☉ = NON-STOCKED PRODUCT

For details, see Ameristar's Sales Policy in the catalog guide.

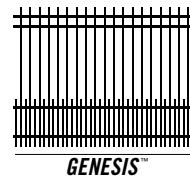
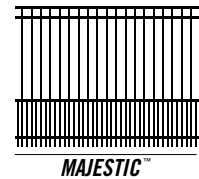
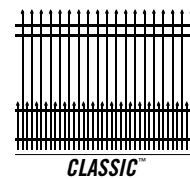

Effective: 01/06/15

ECHELON PLUS® | FINIALS & ADORNMENTS

FINIALS & PICKET PLUGS FOR GENESIS PANELS ONLY | ADORNMENTS FOR 3-RAIL PANELS ONLY

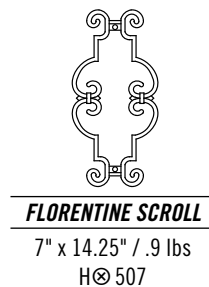
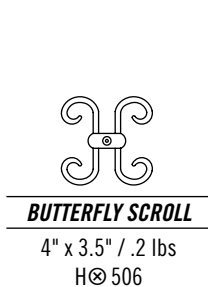
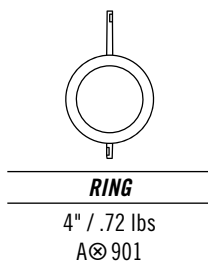
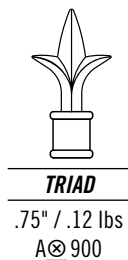
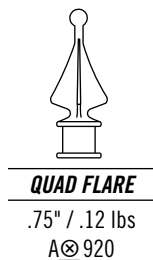

.75" PRESS FIT PICKET FINIALS

» 19 finials required per panel

⊗ = COLOR OPTIONS AVAILABLE | **B** = Black **N** = Bronze
W = White

NOTE: Picket plugs are available in bag quantities only /
 19 plugs per bag
 Item number: PB7519P = **B** / PW7519P = **W**

ECHELON PLUS PANEL ADORNMENTS

» #10 x .75" self-drilling screws included
 » H⊗507 & H⊗0506 = 20 per box | A⊗901 = 18 per box

⊗ = COLOR OPTIONS AVAILABLE | **B** = Black **N** = Bronze
W = White

ECHELON PLUS® | CUSTOM FINISHES

WARRANTY ON CUT COMPONENTS VOID WITHOUT PROPER TOUCH-UP APPLICATION*

*For details & the guidelines for the proper 3-step process, see Ameristar's Sales Policy in the catalog guide

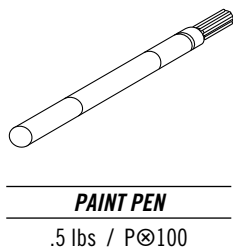

⊗ = COLOR OPTIONS AVAILABLE | **B** = Black **N** = Bronze **W** = White

Effective: 01/06/15

ECHELON PLUS® | BULK RAILS & PICKETS

RAILS & PICKETS AVAILABLE IN BOX QTY ONLY | 540 RAILS PER PALLET

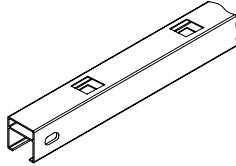

DESCRIPTION	PANEL HEIGHT	LENGTH	ITEM NUMBER	BOX QTY	BOX WEIGHT
ForeRunner Rail / Through Punched	8'	91.75"	AC⊗R18R	18	68 lbs
	6'	73.0625"	AC⊗R16R	18	55 lbs

Used for all rails on Classic, Genesis & Warrior styles. Includes grommets & retaining rods.

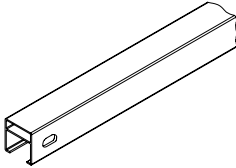

ForeRunner Rail / Flush Top	8'	91.75"	AM⊗R18R	18	68 lbs
	6'	73.0625"	AM⊗R16R	18	55 lbs
ForeRunner Ring Rail / Flush Top	8'	91.75"	AMR⊗R18R	18	68 lbs
	6'	73.0625"	AMR⊗R16R	18	55 lbs

Used for top rails on Monarch, Majestic & Conqueror styles. Includes retaining rods.

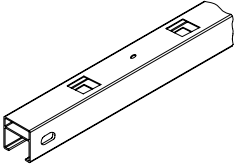

ForeRunner Ring Rail / Through Punched	8'	91.75"	AR⊗R18R	18	68 lbs
	6'	73.0625"	AR⊗R16R	18	55 lbs

Used for second rail on all panels with rings. Includes grommets & retaining rods.

⊗ = COLOR OPTIONS AVAILABLE | **B** = Black **N** = Bronze **W** = White

PANEL STYLES	PICKET DESCRIPTION	PICKET LENGTH	ITEM NUMBER	BOX QTY	BOX WEIGHT	STOCKING
Classic / Majestic / Genesis	Full Length	46"	A ⊠⊗348	114	65 lbs	CB MB GB
Classic / Majestic / Genesis	Full Length	58"	A ⊠⊗360	114	83 lbs	CB MB GB
Classic / Majestic / Genesis	Full Length	70"	A ⊠⊗472	114	99 lbs	MB
Conqueror	Full Length	46"	A LR ⊗348	114	69 lbs	⊖
Conqueror	Full Length	54"	A LR ⊗354	114	69 lbs	⊖
Conqueror	Full Length	58"	A LR ⊗360	114	69 lbs	⊖
Conqueror	Full Length	70"	A LR ⊗372	114	69 lbs	⊖
Majestic	Full Length	54"	A M ⊗354	114	69 lbs	MB
Monarch	Full Length	48"	A M ⊗248*	114	65 lbs	MB
Warrior	Short	43"	A W ⊗348	114	65 lbs	WB
Warrior	Short	55"	A W ⊗360	114	83 lbs	WB
Warrior	Short	67"	A W ⊗472	114	99 lbs	⊖
Conqueror	Short	43"	A R ⊗348	114	61 lbs	⊖
Conqueror	Short	51"	A R ⊗354	114	77 lbs	⊖
Conqueror	Short	55"	A R ⊗360	114	83 lbs	⊖
Conqueror	Short	67"	A R ⊗472	114	99 lbs	⊖

⊠ = FENCE STYLES AVAILABLE | **C** = Classic **M** = Majestic / Monarch* **G** = Genesis **W** = Warrior **R** = Conqueror

⊗ = COLOR OPTIONS AVAILABLE | **B** = Black **N** = Bronze **W** = White

⊖ = NON-STOCKED PRODUCT

For details, see Ameristar's Sales Policy in the catalog guide. Note: Full length Classic pickets are used for the Warrior style.

* Flush bottom per pool requirements. Check pool code regulations in your installation area for specific requirements.

Effective: 01/06/15

TO PLACE YOUR ORDER CALL 888-333-3422 | VISIT AMERISTARFENCE.COM

AMERISTAR
ASSA ABLOY

ECHELON PLUS® | ALUMINUM SQUARE POSTS

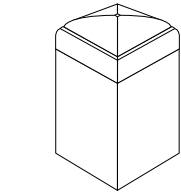

ALUMINUM POSTS

POST LENGTH	ITEM NUMBER	WEIGHT
5' 9"	AP⊗ 25069	5 lbs
6' 3"	AP⊗ 25075	6 lbs
6' 9"	AP⊗ 25081	6 lbs
7' 9"	AP⊗ 25093	7 lbs
8' 9"	AP⊗ 25105	8 lbs
2.5"sq. x .060 wall		
7'	AP⊗ 30084	12 lbs
8'	AP⊗ 30096	14 lbs
9'	AP⊗ 30108	15 lbs
10'	AP⊗ 30120	17 lbs
3"sq. x .125 wall		
7'	AP⊗ 40084	31 lbs
8'	AP⊗ 40096	36 lbs
9'	AP⊗ 40108	40 lbs
10'	AP⊗ 40120	43 lbs
4"sq. x .250 wall		

⊗ = COLOR OPTIONS AVAILABLE | **B** = Black **N** = Bronze **W** = White

ECHELON PLUS® | ORNAMENTAL STEEL SQUARE POSTS

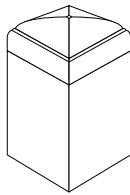

STEEL POSTS

POST LENGTH	ITEM NUMBER	WEIGHT
5'	P⊗ 30060	20 lbs
6'	P⊗ 30072	24 lbs
7'	P⊗ 30084	30 lbs
8'	P⊗ 30096	34 lbs
9'	P⊗ 30108	39 lbs
10'	P⊗ 30120	43 lbs
3"sq. x 12 ga.		
6'	P⊗ 40072	39 lbs
7'	P⊗ 40084	47 lbs
8'	P⊗ 40096	54 lbs
9'	P⊗ 40108	61 lbs
10'	P⊗ 40120	67 lbs
4"sq. x 11 ga.		

⊗ = COLOR OPTIONS AVAILABLE | **B** = Black **N** = Bronze **W** = White

Effective: 01/06/15

ECHELON PLUS® | BRACKETS & PANEL ACCESSORIES

AVAILABLE IN BAG QTY ONLY

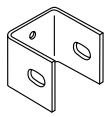
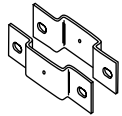
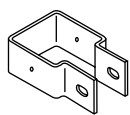
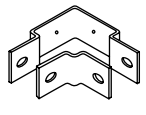
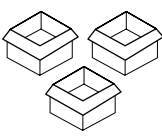
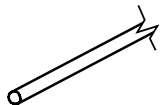
	DESCRIPTION	SIZE	ITEM NUMBER	BAG QTY	BOX QTY	WEIGHT
	Swivel Bracket	1.5"	AB⊗2	2	90	.14 lbs
	<i>Bags packaged with: Self-drilling screws</i>					
	DESCRIPTION	SIZE	ITEM NUMBER	BAG QTY	BOX QTY	WEIGHT
	Flat Mount Bracket	1.5"	AB⊗1	2	240	.10 lbs
	<i>Bags packaged with: #14 x .75" self-drilling screws .25" x 2" carriage bolts .25" flange nuts</i>					
	DESCRIPTION	SIZE	ITEM NUMBER	BAG QTY	BOX QTY	WEIGHT
	Line Boulevard Bracket	2.5" sq	AB⊗3	2	100	.41 lbs
	<i>For joining two adjacent panels in line. Fasteners included.</i>					
	DESCRIPTION	SIZE	ITEM NUMBER	BAG QTY	BOX QTY	WEIGHT
	End Boulevard Bracket	2.5" sq	AB⊗4	2	80	.34 lbs
	<i>For joining post to last panel in line. Fasteners included.</i>					
	DESCRIPTION	SIZE	ITEM NUMBER	BAG QTY	BOX QTY	WEIGHT
	Corner Boulevard Bracket	2.5" sq	AB⊗5	2	100	.41 lbs
	<i>For joining two panels that meet at right angles. Fasteners included.</i>					
	DESCRIPTION	SIZE	ITEM NUMBER	BAG QTY	BOX QTY	WEIGHT
	Grommet Sets	.75" sq.	⊗G7520P	20	n/a	.25 lbs
	DESCRIPTION	SIZE	ITEM NUMBER	BAG QTY	BOX QTY	WEIGHT
	Retaining Rod	91.75"	H533P	1	1	.32 lbs
		71.375"	H532P	1	1	.25 lbs
	<i>Galvanized rod / .125" diameter</i>					

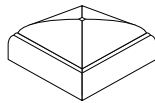

STANDARD FLAT CAP
Aluminum



BALL CAP
Aluminum

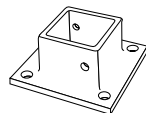

POST BASE
Aluminum

CAP SIZE	ITEM NUMBER	WEIGHT EA.
2.5"sq	A⊗600P	.2 lbs
3"sq	A⊗700P	.3 lbs
4"sq	A⊗800P	.4 lbs

CAP SIZE	ITEM NUMBER	WEIGHT EA.
2.5"sq	A⊗513	.7 lbs
3"sq	A⊗516	.8 lbs
4"sq	A⊗517	2 lbs

BASE SIZE	ITEM NUMBER	WEIGHT EA.
5" sq	APB⊗25	2 lbs

⊗ = COLOR OPTIONS AVAILABLE | **B** = Black **N** = Bronze **W** = White

Effective: 01/06/15

ECHELON PLUS® | FASTENERS

AVAILABLE IN BOX QUANTITIES ONLY

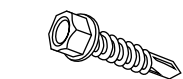

DESCRIPTION	ITEM NUMBER	BAG QTY	ITEM WEIGHT
#14 x .75" Self-Drilling Screws	1-0004- <u>⊗</u> P-50	50	.6 lbs
#10 x .75" Self-Drilling Screws	1-0002- <u>⊗</u> P-50	50	.35 lbs

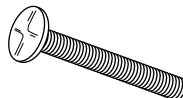

#10 x .625" Phillips Screws	1-0005- <u>⊗</u> P	1	.005 lbs
<i>For setting angle on swivel brackets</i>			

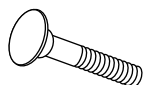

.25" x 2" Carriage Bolts	H <u>⊗</u> 516P	1	.03 lbs
.3125" x .75" Carriage Bolts	H <u>⊗</u> 582P	1	.025 lbs
<i>2" carriage bolts for brackets / .75" carriage bolts for post base</i>			



.25" x .28125" Drive Rivets	H <u>⊗</u> 559P	1	.002 lbs
<i>For use with flat mount brackets</i>			



.25" Flange Nuts	3-0001- <u>⊗</u> P-20	20	.3 lbs
------------------	-----------------------	----	--------



.3125" Hex Nuts	3-0002- <u>⊗</u> P	1	.011 lbs
-----------------	--------------------	---	----------

⊗ = COLOR OPTIONS AVAILABLE | B = Black N = Bronze W = White

⊗ = COLOR OPTIONS AVAILABLE | 1 = Black 2 = Bronze 4 = White

Effective: 01/06/15

Effective: 01/06/15

TO PLACE YOUR ORDER CALL 888-333-3422 | VISIT AMERISTARFENCE.COM

AMERISTAR®
ASSA ABLOY

ECHELON PLUS® | CONSTRUCTION SPECIFICATION 32 31 19

ALUMINUM ORNAMENTAL FENCE SYSTEM – INTERNALLY SECURED

PART 1 - GENERAL

1.01 WORK INCLUDED

The contractor shall provide all labor, materials and all necessary items for the installation of the Echelon Plus® ornamental aluminum fence system defined herein at (specify project site).

1.02 RELATED WORK

Section ___ - Earthwork

Section ___ - Concrete

1.03 SYSTEM DESCRIPTION

The manufacturer shall supply a total ornamental aluminum fencing system of the Ameristar® Echelon Plus® (specify *Classic™, Majestic™, Genesis™, Warrior™, Conqueror™, Monarch Pool™, Majestic Pool™, Conqueror Pool™, Classic Puppy™, Majestic Puppy™, or Genesis Puppy™*) design. The system shall include all components (*i.e., pickets, posts, rails, gates and hardware*) required.

1.04 QUALITY ASSURANCE

The contractor shall provide laborers and supervisors who are thoroughly familiar with the type of construction involved and the materials specified.

1.05 REFERENCES

- **ASTM B117** – Practice for Operating Salt-Spray (Fog) Apparatus
- **ASTM B221** – Standard Specification for Aluminum and Aluminum-Alloy Extruded Bars, Rods, Wire, Profiles and Tubes
- **ASTM D523** – Test Method for Specular Gloss
- **ASTM D822** – Practice for Conducting Tests on Paint and Related Coatings and Materials using Filtered Open-Flame Carbon-Arc Light and Water Exposure Apparatus
- **ASTM D1654** – Test Method for Evaluation of Painted or Coated Specimens Subjected to Corrosive Environments
- **ASTM D2244** – Test Method for Calculation of Color Differences from Instrumentally Measured Color Coordinates
- **ASTM D2794** – Test Method for Resistance of Organic Coatings to the Effects of Rapid Deformation (Impact)
- **ASTM D3359** – Test Method for Measuring Adhesion by Tape Test

1.06 SUBMITTAL

The manufacturer's submittal package shall be submitted prior to installation to confirm compliance with all requirements for materials specified in this section.

1.07 PRODUCT HANDLING AND STORAGE

Upon receipt at the job site, all materials shall be checked to ensure that no damages occurred during shipping or handling. Materials shall be stored in such a manner to ensure proper ventilation and drainage and to protect against damage, weather, vandalism and theft.

PART 2 - MATERIALS

2.01 MANUFACTURER

The ornamental fence system shall conform to Ameristar's Echelon Plus aluminum ornamental fencing, (*specify Classic, Majestic, Genesis, Warrior, Conqueror, Monarch Pool, Majestic Pool, Conqueror Pool, Classic Puppy, Majestic Puppy, or Genesis Puppy*) (*specify 2-rail, 3-rail, 4-rail, 3-rail with rings, or 4-rail with rings*) style manufactured by Ameristar Fence Products, Inc. in Tulsa, Oklahoma.

2.02 MATERIAL

- A. Aluminum material for fence framework (*i.e., tubular pickets, rails and posts*) shall conform to the requirements of **ASTM B221**. The aluminum extrusions for posts and rails shall be Alloy and Temper Designation **6005-T52**. The aluminum extrusions for pickets shall be Alloy and Temper Designation **6063-T52**.
- B. Pickets shall be 3/4" square x .045" thick. Horizontal rails shall be 1-1/4" x 1-7/16" Forerunner™ channel with .060" thick top & internal web wall, and .090" thick side walls and shall be punched to allow picket to pass through the top of the rail. The Forerunner rail shall be constructed with an internal web providing a raceway for the pickets to be retained with a 1/8" retaining rod. The number of rails shall vary with the style, height and strength as determined by manufacturer. Fence posts and gate posts shall meet the minimum size requirements of **Table 1**.
- C. Accessories: Aluminum castings shall be used for all post caps, scrolls, finials, and other miscellaneous hardware. Hinges and latches shall be fabricated from aluminum, stainless steel or composite materials.

2.03 FABRICATION

- A. Pickets, rails and posts shall be pre-cut to specified lengths. ForeRunner rails shall be pre-punched to accept pickets. Grommets shall be inserted into the pre-punched holes in the rails and pickets shall be inserted through the grommets so that pre-drilled picket holes align with the internal upper raceway of the ForeRunner rails (*Note: This can best be accomplished by using an alignment template*). Retaining rods shall be inserted into each ForeRunner rail so that they pass through the pre-drilled holes in each picket, thus completing the panel assembly.

Effective: 01/06/15

ECHELON PLUS® | CONSTRUCTION SPECIFICATION 32 31 19

ALUMINUM ORNAMENTAL FENCE SYSTEM – INTERNALLY SECURED

- B.** The manufactured framework shall be subjected to the Ameristar thermal stratification coating process (*high-temperature, in-line, multi-stage, and multi-layer*) including, as a minimum, a six-stage pretreatment/wash and an electrostatic spray application of a polyester finish. The topcoat shall be a “no-mar” TGIC polyester powder coat finish with a minimum thickness of 2 mils (0.0508mm). The color shall be (specify Black, Bronze, or White). The stratification-coated framework shall be capable of meeting the performance requirements for each quality characteristic shown in **Table 2**.
- C.** Finish: All fence components shall be subject to a six-stage pretreatment/wash followed by an electrostatic spray application of a “no-mar” TGIC polyester powder coat finish with a minimum thickness of 2-4 mils. The color shall be (*specify black, bronze or white*).
- D.** Completed panels shall be capable of supporting a 200 lb. load (*applied at midspan*) without permanent deformation. Panels without rings shall be biasable to a 12.5% change in grade.
- E.** Swing gates shall be fabricated using 1-1/4" x 1-7/16" Forerunner rail, 1.75" sq. x .125" gate ends, and 3/4" sq. x .080 pickets. Gates that exceed 6' in width will have a 1.75" sq. x .125" intermediate upright. All rail and upright intersections shall be joined by welding. All picket and rail intersections shall also be joined by welding.

PART 3 - EXECUTION

3.01 PREPARATION

All new installation shall be laid out by the contractor in accordance with the construction plans.

3.02 FENCE INSTALLATION

Fence post shall be spaced according to **Table 3**, plus or minus 1/2". For installations that must be raked to follow sloping grades, the post spacing dimension must be measured along the grade. Fence panels shall be attached to posts with brackets supplied by the manufacturer. Posts shall be set in concrete footers 33" depth recommended (*Note: In some cases, local restrictions of freezing weather conditions may require a greater depth*). The “Earthwork” and “Concrete” sections of this specification shall govern material requirements for the concrete footer. Posts setting by other methods such as plated posts or grouted core-drilled footers are permissible only if shown by engineering analysis to be sufficient in strength for the intended application.

3.03 FENCE INSTALLATION MAINTENANCE

When cutting/drilling rails or posts adhere to the following steps to seal the exposed surfaces; 1) Remove all metal shavings from cut area. 2) Apply custom finish paint matching fence color. Failure to seal exposed surfaces per steps 1 & 2 above will negate warranty. Ameristar spray cans or paint pens shall be used to finish exposed surfaces; it is recommended that paint pens be used to prevent overspray. Use of non-Ameristar parts or components will negate the manufactures’ warranty.

3.04 GATE INSTALLATION

Gate posts shall be spaced according to the manufacturers’ gate drawings, dependent on standard out-to-out gate leaf dimensions and gate hardware selected. Type and quantity of gate hinges shall be based on the application; weight, height, and number of gate cycles. The manufacturers’ gate drawings shall identify the necessary gate hardware required for the application. Gate hardware shall be provided by the manufacture of the gate and shall be installed per manufacturer’s recommendations.

3.05 CLEANING

The contractor shall clean the jobsite of excess materials; post-hole excavations shall be scattered uniformly away from posts.

SEE REFERENCED TABLES ON THE FOLLOWING PAGE

Effective: 01/06/15

ECHELON PLUS® | CONSTRUCTION SPECIFICATION 32 31 19

ALUMINUM ORNAMENTAL FENCE SYSTEM – INTERNALLY SECURED

TABLE 1

MINIMUM SIZES FOR ECHELON PLUS POSTS			
FENCE POSTS		PANEL HEIGHTS	
2½" x 2½" x .060" w/reinforced web		up to and including 6' height	
GATE LEAF	GATE HEIGHT		
	up to & including 4'	over 4' up to & including 5'	over 5' up to & including 6'
up to 4'	2½" x 2½" x .060 alum.	3" x 3" x .120" alum.	4" x 4" x .250" alum. or 3" x 3" 12 ga. steel
4'1" to 6'	3" x 3" x .120" alum.	4" x 4" x .250" alum. or 3" x 3" 12 ga. steel	3" x 3" 12 ga. steel
6'1" to 8'	4" x 4" x .250" alum. or 3" x 3" 12 ga. steel	4" x 4" x 11 ga. steel	4" x 4" x 11 ga. steel

TABLE 2

COATING PERFORMANCE REQUIREMENTS		
QUALITY CHARACTERISTICS	ASTM TEST METHOD	PERFORMANCE REQUIREMENTS
ADHESION	D3359 – METHOD B	Adhesion (<i>retention of coating</i>) over 90% of test area (<i>tape and knife kit test</i>).
CORROSION RESISTANCE	B117, D714, D1654	Corrosion resistance over 1,500 hours (<i>scribed per D1654; failure mode is accumulation of 1/8" coating loss from scribe or medium #8 blisters</i>)
IMPACT RESISTANCE	D2794	Impact resistance over 60" lb. (<i>forward impact using 0.625" ball</i>).
WEATHERING RESISTANCE	D822 D2244, D523 (60° method)	Weathering resistance over 1,000 hours (<i>failure mode is 60% loss of gloss or color variance of more than 3 delta-E color units</i>).

TABLE 3

ECHELON PLUS POST SPACING BY BRACKET TYPE					
SPAN	8' nominal (91.75" rail)				
POST SIZE	2½"	2½"	3"	2½"	3"
BRACKET TYPE	Echelon Plus Line Blvd. (ABB3)	Echelon Plus Swivel* (ABB2)		Echelon Plus Flat Mount (ABB1)	
POST SETTINGS ± ¼" O.C.	95"	*95"	*95½"	95"	95½"

TABLE 3

SPAN	6' nominal (73.0625" rail)				
POST SIZE	2½"	2½"	3"	2½"	3"
BRACKET TYPE	Echelon Plus Line Blvd. (ABB3)	Echelon Plus Swivel* (ABB2)		Echelon Plus Flat Mount (ABB1)	
POST SETTINGS ± ¼" O.C.	76¼"	*76¼"	*76¼"	76¼"	76¼"

*When using ABB2 swivel brackets on either or both ends of a panel installation, care must be taken to ensure the spacing between post and adjoining pickets meets applicable codes. This will require trimming one or both ends of the panel.

TABLE 4

ECHELON PLUS WIND LOADING				
FENCE HEIGHT	RAIL LENGTH	POST SIZE	WIND LOAD CAPACITY FACTOR (PSF)	TYPICAL WIND LOAD CAPACITY (MPH)
4'	6'	2½" x 2½" tube w/reinforced web	85 (PSF)	215 (MPH)
	8'	2½" x 2½" tube w/reinforced web	68 (PSF)	193 (MPH)
5'	8'	2½" x 2½" tube w/reinforced web	47 (PSF)	159 (MPH)
6'	8'	2½" x 2½" tube w/reinforced web	42 (PSF)	151 (MPH)

MPH values shown in Table 4 are provided for information only. They are calculated using ANSI/ASCE 7-05, "American Society of Civil Engineers Minimum Design Loads for Buildings and Other Structures" Exposure Category C (open terrain with scattered obstructions having lengths generally less than 30 feet), based on post setting in 36" deep concrete footer in soil assumed to be of mid-range strength and compaction. Since specified project conditions such as jurisdictional building codes, elevation of installation, post base/footer design, soil strength, etc., may change from project to project, a structural engineering evaluation, unique to applicable requirements and conditions, should be performed. Consult your Ameristar Service Representative for an estimate on Engineering Analysis and P.E. Certification.

Effective: 01/06/15

ECHELON PLUS® | LIMITED LIFETIME WARRANTY

COMMERCIAL ALUMINUM ORNAMENTAL FENCE

Echelon Plus® Commercial Aluminum Ornamental Fence System by Ameristar® is manufactured from the highest quality materials by skilled craftsmen to meet the highest standards of workmanship in the industry. Extruded aluminum framework shall be subject to a six stage pretreatment/wash followed by an electrostatic spray application of “no-mar” TGIC polyester powder coat finish, which provides the protection necessary to withstand adverse environmental conditions.

The powder coated surface on all aluminum framework (*i.e., pickets, rails and posts*) by Ameristar is guaranteed under normal and proper usage, against cracking, peeling, chipping, blistering or corroding for a lifetime limited period. Normal and proper usage does not include physical damage, abrasion or exposure to salty environments to the protective coating.

Echelon Plus Commercial Aluminum Ornamental Fence System framework is also guaranteed for the same period of time against defects in workmanship or materials.

Should any ornamental fence framework manufactured by Ameristar Fence Products fail in accordance with any of the above conditions, Ameristar Fence Products warrants to the original purchaser their redemption through replacement or renewal. The decision as to which method of redemption is allowed is solely at the discretion of Ameristar. Notice of failure under the conditions of this warranty shall be sent to Ameristar Fence Products or its authorized representative, in writing, together with proof of purchase and shall specify the nature of the defect and when it was first observed. Should the fence be improperly installed, Ameristar Fence Products shall not be responsible for guaranteed performance or appearance of the material. Neither does this guarantee apply when failure or damage is due to improper use or application, abuse or misuse, vandalism or acts of God. Ameristar Fence Products reserves the right to inspect the material to determine validity of the claim.

Upon validation of the claim by Ameristar Fence Products or its authorized representative, redemption by replacement or renewal shall be made by Ameristar Fence Products. Reimbursement for the costs of removal and installation of materials are not included in the guarantee, nor will Ameristar Fence Products provide those services.

The above constitutes the complete warranty by the manufacturer. No other agreement, written or implied, is valid. Ameristar Fence Products does not authorize any other person or agent to make any other express warranties. Ameristar Fence Products neither assumes nor authorizes any other person or agent to assume any other liability in connection with Echelon Plus Commercial Aluminum Ornamental Fence System. Some jurisdictions do not allow limitations on how long an implied warranty lasts, nor do they allow an exclusion or limitation of incidental or consequential damages; therefore, the limitations and exclusions noted herein may not apply.

Effective: 01/06/15

ECHELON PLUS® | SINGLE SWING GATE SPECIFICATIONS

1.75"sq x .125" wall GATE ENDS | 1.25" ForeRunner™ RAILS | .75"sq x .080" wall PICKETS

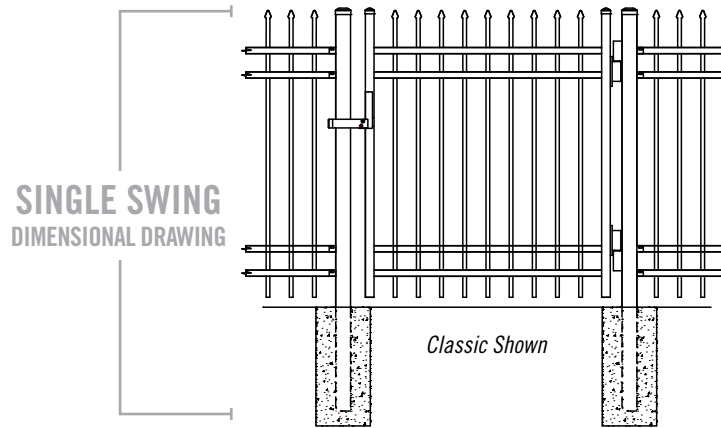

SINGLE SWING
 HARDWARE KITS & POST
 INTERSPACES

OPENING	LEAF WIDTH*	TCSGK TRU-CLOSE HINGE KIT			AGBS25 / SGBS3 BOLT-ON HARDWARE KITS			SGBS25A / SGBS3A AMERISTAR LOCK / BOLT-ON HINGE KIT		
		HC	LC	P _S	HC	LC	P _S	HC	LC	P _S
3.5'	40"	.75"	.75"	41.5"	2"	2"	44"	2"	.625"	42.625"
4'	49.5"	.75"	.75"	51"	2"	2"	53.5"	2"	.625"	52.125"
5'	58.75"	.75"	.75"	60.25"	2"	2"	62.75"	2"	.625"	61.375"
6'	68"	.75"	.75"	69.5"	2"	2"	72"	2"	.625"	70.625"

W = width* | HC = hinge clearance | LC = latch clearance | P_S = gate post spacing**
 * From outside to outside | ** From inside to inside

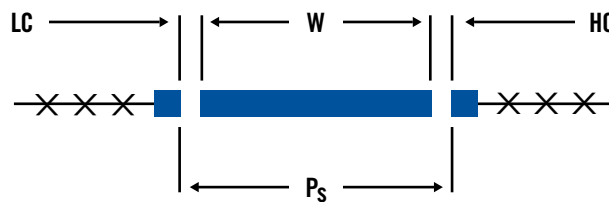

Effective: 01/06/15

ECHELON PLUS® | DOUBLE SWING GATE SPECIFICATIONS

1.75"sq x .125" wall GATE ENDS | 1.25" ForeRunner™ RAILS | .75"sq x .080" wall PICKETS

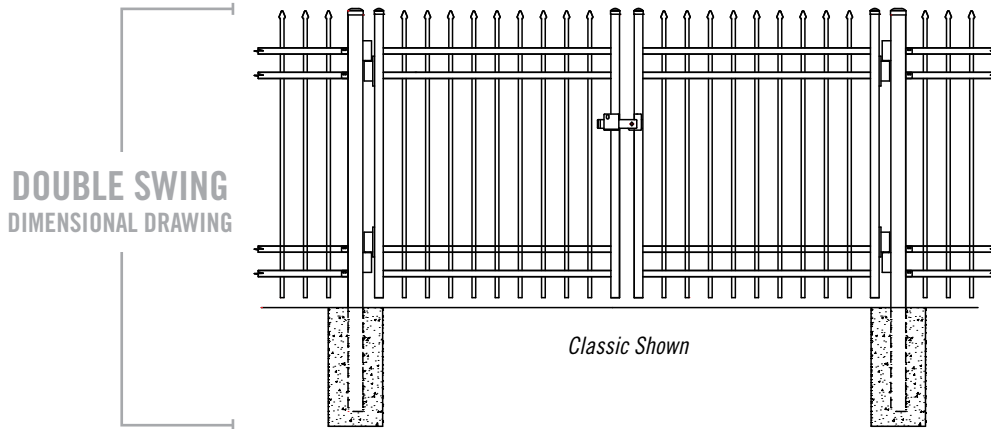

OPENING	LEAF WIDTH*	AGBD BOLT-ON HINGE KITS			AGBDX BOX HINGE KIT WITH UPRIGHT			CGBD COMMERCIAL HINGE KIT W/ STRONGARM		
		HC	LC	P _d	HC	LC	P _d	HC	LC	P _d
7'	40"	2"	2"	86"	2.375"	2"	86.75"	1"	2"	84"
8'	49.5"	2"	2"	105"	2.375"	2"	105.75"	1"	2"	103"
10'	58.75"	2"	2"	123.5"	2.375"	2"	124.25"	1"	2"	121.5"
12'	68"	2"	2"	142"	2.375"	2"	142.75"	1"	2"	140"

DOUBLE SWING HARDWARE KITS & POST INTERSPACES

W = width (x2)* | HC = hinge clearance (x2) | LC = latch clearance | P_d = gate post spacing**
 * From outside to outside | ** From inside to inside

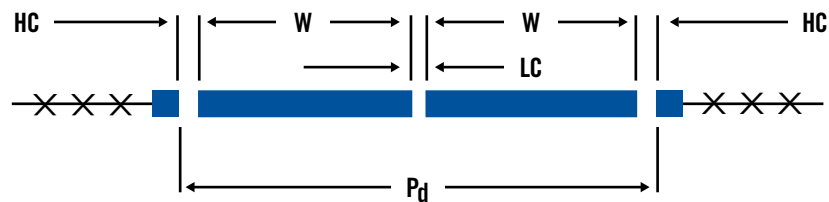

Effective: 01/06/15

ECHELON PLUS® | 3-RAIL SINGLE SWING GATES

STANDARD BOTTOM | GATE HARDWARE NOT INCLUDED

	OPENING	LEAF WIDTH	ITEM NUMBER	PICKET QTY	WEIGHT	STOCKING
3' HEIGHT	3½'	40"	A☒⊗336-42	7	19 lbs	⊙
	4'	49.5"	A☒⊗336-48	9	24 lbs	⊙
	5'	58.75"	A☒⊗336-60	11	28 lbs	⊙
3½' HEIGHT	3½'	40"	A☒⊗342-42	7	21 lbs	⊙
	4'	49.5"	A☒⊗342-48	9	26 lbs	⊙
	5'	58.75"	A☒⊗342-60	11	30 lbs	⊙
4' HEIGHT	3½'	40"	A☒⊗348-42	7	23 lbs	⊙
	4'	49.5"	A☒⊗348-48	9	28 lbs	⊙
	5'	58.75"	A☒⊗348-60	11	32 lbs	⊙
5' HEIGHT	3½'	40"	A☒⊗360-42	7	27 lbs	⊙
	4'	49.5"	A☒⊗360-48	9	32 lbs	⊙
	5'	58.75"	A☒⊗360-60	11	36 lbs	⊙
6' HEIGHT	3½'	40"	A☒⊗372-42	7	31 lbs	⊙
	4'	49.5"	A☒⊗372-48	9	36 lbs	⊙
	5'	58.75"	A☒⊗372-60	11	40 lbs	⊙
	6'	68"	A☒⊗372-72	13	46 lbs	⊙

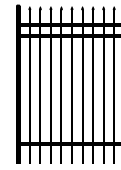

CLASSIC™

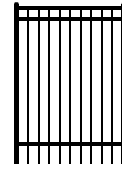

MAJESTIC™

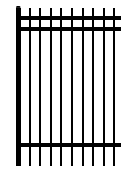

GENESIS™

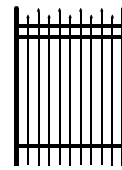

WARRIOR™

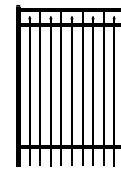

CONQUEROR™

☒ = FENCE STYLES AVAILABLE | C = Classic M = Majestic G = Genesis W = Warrior R = Conqueror

⊗ = COLOR OPTIONS AVAILABLE | B = Black N = Bronze W = White

⊙ = NON-STOCKED PRODUCT

For details, see Ameristar's Sales Policy in the catalog guide.

Effective: 01/06/15

ECHELON PLUS® | 3-RAIL SINGLE SWING GATES

FLUSH BOTTOM | GATE HARDWARE NOT INCLUDED

	OPENING	LEAF WIDTH	ITEM NUMBER	PICKET QTY	WEIGHT	STOCKING
3' HEIGHT	3½'	40"	A☒☒336-42F	7	19 lbs	☉
	4'	49.5"	A☒☒336-48F	9	24 lbs	☉
	5'	58.75"	A☒☒336-60F	11	28 lbs	☉
3½' HEIGHT	3½'	40"	A☒☒342-42F	7	21 lbs	☉
	4'	49.5"	A☒☒342-48F	9	26 lbs	☉
	5'	58.75"	A☒☒342-60F	11	30 lbs	☉
4' HEIGHT	3½'	40"	A☒☒348-42F	7	23 lbs	☉
	4'	49.5"	A☒☒348-48F	9	28 lbs	☉
	5'	58.75"	A☒☒348-60F	11	32 lbs	☉
5' HEIGHT	3½'	40"	A☒☒360-42F	7	27 lbs	☉
	4'	49.5"	A☒☒360-48F	9	32 lbs	☉
	5'	58.75"	A☒☒360-60F	11	36 lbs	☉
6' HEIGHT	3½'	40"	A☒☒372-42F	7	31 lbs	☉
	4'	49.5"	A☒☒372-48F	9	36 lbs	☉
	5'	58.75"	A☒☒372-60F	11	40 lbs	☉
	6'	68"	A☒☒372-72F	13	46 lbs	☉

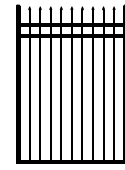

CLASSIC™

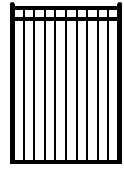

MAJESTIC™

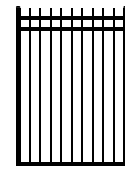

GENESIS™

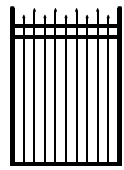

WARRIOR™

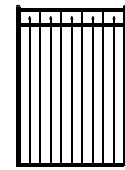

CONQUEROR™

☒ = FENCE STYLES AVAILABLE | C = Classic M = Majestic G = Genesis W = Warrior R = Conqueror

☒ = COLOR OPTIONS AVAILABLE | B = Black N = Bronze W = White

☉ = NON-STOCKED PRODUCT

For details, see Ameristar's Sales Policy in the catalog guide.

*Flush bottom per pool requirements. Check pool code regulations in your installation area for specific requirements.

Effective: 01/06/15

ECHELON PLUS® | 3-RAIL SINGLE SWING GATES WITH RINGS

STANDARD BOTTOM | GATE HARDWARE NOT INCLUDED

	OPENING	LEAF WIDTH	ITEM NUMBER	PICKET QTY	WEIGHT	STOCKING
4' HEIGHT	3½'	40"	A☒ⓧ348-42R	7	25 lbs	⊙
	4'	49.5"	A☒ⓧ348-48R	9	31 lbs	⊙
	5'	58.75"	A☒ⓧ348-60R	11	35 lbs	⊙
	6'	68"	A☒ⓧ348-72R	13	40 lbs	⊙
5' HEIGHT	3½'	40"	A☒ⓧ360-42R	7	29 lbs	⊙
	4'	49.5"	A☒ⓧ360-48R	9	35 lbs	⊙
	5'	58.75"	A☒ⓧ360-60R	11	39 lbs	⊙
	6'	68"	A☒ⓧ360-72R	13	45 lbs	⊙

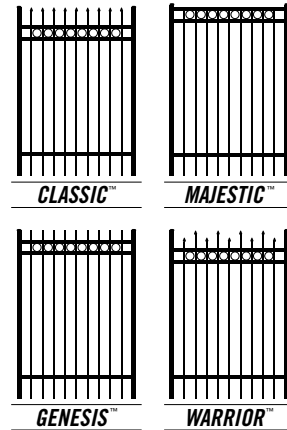

☒ = FENCE STYLES AVAILABLE | **C** = Classic **M** = Majestic **G** = Genesis **W** = Warrior

ⓧ = COLOR OPTIONS AVAILABLE | **B** = Black **N** = Bronze **W** = White

⊙ = NON-STOCKED PRODUCT

For details, see Ameristar's Sales Policy in the catalog guide.

Effective: 01/06/15

ECHELON PLUS® | 4-RAIL SINGLE SWING GATES

STANDARD BOTTOM | GATE HARDWARE NOT INCLUDED

	OPENING	LEAF WIDTH	ITEM NUMBER	PICKET QTY	WEIGHT	STOCKING
4' HEIGHT	3½'	40"	A☒☒448-42	7	25 lbs	☉
	4'	49.5"	A☒☒448-48	9	29 lbs	☉
	5'	58.75"	A☒☒448-60	11	35 lbs	☉
5' HEIGHT	6'	68"	A☒☒448-72	13	40 lbs	☉
	3½'	40"	A☒☒460-42	7	29 lbs	☉
	4'	49.5"	A☒☒460-48	9	34 lbs	☉
6' HEIGHT	5'	58.75"	A☒☒460-60	11	39 lbs	☉
	6'	68"	A☒☒460-72	13	45 lbs	☉
	3½'	40"	A☒☒472-42	7	33 lbs	☉
6' HEIGHT	4'	49.5"	A☒☒472-48	9	39 lbs	☉
	5'	58.75"	A☒☒472-60	11	45 lbs	☉
	6'	68"	A☒☒472-72	13	52 lbs	☉

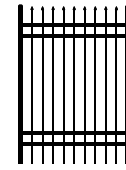

CLASSIC™

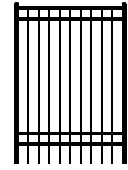

MAJESTIC™

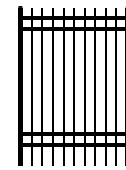

GENESIS™

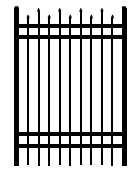

WARRIOR™

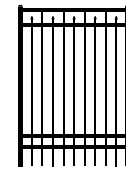

CONQUEROR™

☒ = FENCE STYLES AVAILABLE | C = Classic M = Majestic G = Genesis W = Warrior R = Conqueror

☒ = COLOR OPTIONS AVAILABLE | B = Black N = Bronze W = White

☉ = NON-STOCKED PRODUCT

For details, see Ameristar's Sales Policy in the catalog guide.

ECHELON PLUS® | 4-RAIL SINGLE SWING GATES

FLUSH BOTTOM | GATE HARDWARE NOT INCLUDED

	OPENING	LEAF WIDTH	ITEM NUMBER	PICKET QTY	WEIGHT	STOCKING
4' HEIGHT	3½'	40"	A☒☒448-42F	7	25 lbs	☉
	4'	49.5"	A☒☒448-48F	9	29 lbs	☉
	5'	58.75"	A☒☒448-60F	11	35 lbs	☉
5' HEIGHT	6'	68"	A☒☒448-72F	13	40 lbs	☉
	3½'	40"	A☒☒460-42F	7	29 lbs	☉
	4'	49.5"	A☒☒460-48F	9	34 lbs	☉
6' HEIGHT	5'	58.75"	A☒☒460-60F	11	39 lbs	☉
	6'	68"	A☒☒460-72F	13	45 lbs	☉
	3½'	40"	A☒☒472-42F	7	33 lbs	☉
6' HEIGHT	4'	49.5"	A☒☒472-48F	9	39 lbs	☉
	5'	58.75"	A☒☒472-60F	11	45 lbs	☉
	6'	68"	A☒☒472-72F	13	52 lbs	☉

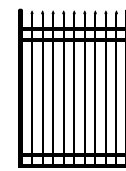

CLASSIC™

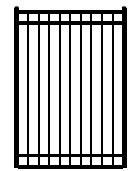

MAJESTIC™

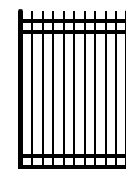

GENESIS™

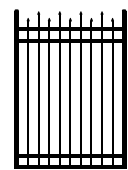

WARRIOR™

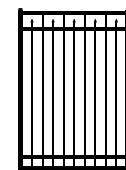

CONQUEROR™

☒ = FENCE STYLES AVAILABLE | C = Classic M = Majestic G = Genesis W = Warrior R = Conqueror

☒ = COLOR OPTIONS AVAILABLE | B = Black N = Bronze W = White

☉ = NON-STOCKED PRODUCT

For details, see Ameristar's Sales Policy in the catalog guide.

Effective: 01/06/15

ECHELON PLUS® | 4-RAIL SINGLE SWING GATES WITH RINGS

STANDARD BOTTOM | GATE HARDWARE NOT INCLUDED

	OPENING	LEAF WIDTH	ITEM NUMBER	PICKET QTY	WEIGHT	STOCKING
6' HEIGHT	3½'	40"	A☒⊗472-42R	7	25 lbs	⊙
	4'	49.5"	A☒⊗472-48R	9	31 lbs	⊙
	5'	58.75"	A☒⊗472-60R	11	35 lbs	⊙
	6'	68"	A☒⊗472-72R	13	40 lbs	⊙

☒ = FENCE STYLES AVAILABLE | **C** = Classic **M** = Majestic **G** = Genesis **W** = Warrior

⊗ = COLOR OPTIONS AVAILABLE | **B** = Black **N** = Bronze **W** = White

⊙ = NON-STOCKED PRODUCT

For details, see Ameristar's Sales Policy in the catalog guide.

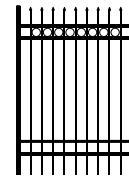

CLASSIC™

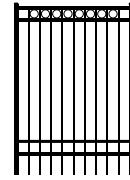

MAJESTIC™

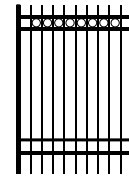

GENESIS™

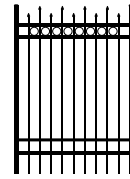

WARRIOR™

Effective: 01/06/15

ECHELON PLUS® | 2-RAIL SINGLE SWING POOL GATES

FLUSH BOTTOM | GATE HARDWARE NOT INCLUDED

OPENING	LEAF WIDTH	ITEM NUMBER	PICKET QTY	WEIGHT	STOCKING
4' HEIGHT	3½' POOL	AM ⊗ 248-42*	7	25 lbs	⊙
	4' POOL	AM ⊗ 248-48*	9	31 lbs	⊙
	5' POOL	AM ⊗ 248-60*	11	35 lbs	⊙
	6' POOL	AM ⊗ 248-72*	13	40 lbs	⊙



MONARCH™

- ⊗ = FENCE STYLES AVAILABLE | **M** = Monarch*
 - ⊗ = COLOR OPTIONS AVAILABLE | **B** = Black **N** = Bronze **W** = White
 - ⊙ = NON-STOCKED PRODUCT
- For details, see Ameristar's Sales Policy in the catalog guide.*

ECHELON PLUS® | 3-RAIL SINGLE SWING POOL GATES

FLUSH BOTTOM | GATE HARDWARE NOT INCLUDED

OPENING	LEAF WIDTH	ITEM NUMBER	PICKET QTY	WEIGHT	STOCKING
4½' HEIGHT	3½' POOL	A⊗ ⊗ 354-42	7	29 lbs	⊙
	4' POOL	A⊗ ⊗ 354-48	9	35 lbs	⊙
	5' POOL	A⊗ ⊗ 354-60	11	39 lbs	⊙
	6' POOL	A⊗ ⊗ 354-72	13	45 lbs	⊙
	3½' POOL	AM ⊗ 354-42R	7	29 lbs	⊙
	4' POOL	AM ⊗ 354-48R	9	35 lbs	⊙
	5' POOL	AM ⊗ 354-60R	11	39 lbs	⊙
	6' POOL	AM ⊗ 354-72R	13	45 lbs	⊙

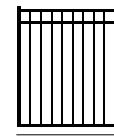

MAJESTIC™

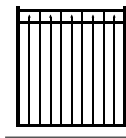

CONQUEROR™

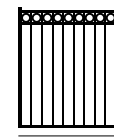

MAJESTIC™

- ⊗ = FENCE STYLES AVAILABLE | **M** = Majestic **R** = Conqueror
 - ⊗ = COLOR OPTIONS AVAILABLE | **B** = Black **N** = Bronze **W** = White
 - ⊙ = NON-STOCKED PRODUCT
- For details, see Ameristar's Sales Policy in the catalog guide.*

Effective: 01/06/15

ECHELON PLUS® | 3-RAIL SINGLE SWING PUPPY GATES

STANDARD BOTTOM | GATE HARDWARE NOT INCLUDED

	OPENING	LEAF WIDTH	ITEM NUMBER	PICKET QTY	WEIGHT	STOCKING
4' HEIGHT	3½'	40"	A☒ⓧ348-42D	7	27 lbs	⊙
	4'	49.5"	A☒ⓧ348-48D	9	33 lbs	⊙
	5'	58.75"	A☒ⓧ348-60D	11	37 lbs	⊙
	6'	68"	A☒ⓧ348-72D	13	43 lbs	⊙
5' HEIGHT	3½'	40"	A☒ⓧ360-42D	7	31 lbs	⊙
	4'	49.5"	A☒ⓧ360-48D	9	37 lbs	⊙
	5'	58.75"	A☒ⓧ360-60D	11	42 lbs	⊙
	6'	68"	A☒ⓧ360-72D	13	48 lbs	⊙

☒ = FENCE STYLES AVAILABLE | C = Classic M = Majestic G = Genesis

ⓧ = COLOR OPTIONS AVAILABLE | B = Black N = Bronze W = White

⊙ = NON-STOCKED PRODUCT

For details, see Ameristar's Sales Policy in the catalog guide.

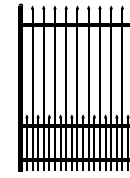

CLASSIC™

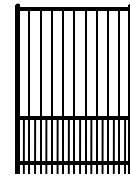

MAJESTIC™

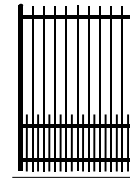

GENESIS™

ECHELON PLUS® | 4-RAIL SINGLE SWING PUPPY GATES

STANDARD BOTTOM | GATE HARDWARE NOT INCLUDED

	OPENING	LEAF WIDTH	ITEM NUMBER	PICKET QTY	WEIGHT	STOCKING
6' HEIGHT	3½'	40"	A☒ⓧ472-42D	7	37 lbs	⊙
	4'	49.5"	A☒ⓧ472-48D	9	44 lbs	⊙
	5'	58.75"	A☒ⓧ472-60D	11	51 lbs	⊙
	6'	68"	A☒ⓧ472-72D	13	59 lbs	⊙

☒ = FENCE STYLES AVAILABLE | C = Classic M = Majestic G = Genesis

ⓧ = COLOR OPTIONS AVAILABLE | B = Black N = Bronze W = White

⊙ = NON-STOCKED PRODUCT

For details, see Ameristar's Sales Policy in the catalog guide.

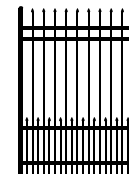

CLASSIC™

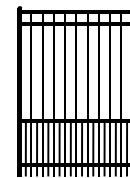

MAJESTIC™

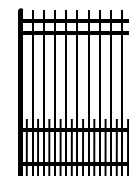

GENESIS™

Effective: 01/06/15

Effective: 01/06/15

TO PLACE YOUR ORDER CALL 888-333-3422 | VISIT AMERISTARFENCE.COM |

AMERISTAR®
ASSA ABLOY

ECHELON II® *ECHELON PLUS®* *ECHELON®*

ECHELON PLUS® | *ORNAMENTAL ALUMINUM FENCE*

Effective: 01/06/15

AMERISTAR
ASSA ABLOY

| *TO PLACE YOUR ORDER CALL 888-333-3422* | *VISIT AMERISTARFENCE.COM*

ECHELON PLUS® | SINGLE SWING GATE SPECIFICATIONS

2"sq x .25" wall GATE ENDS | 1" x 2" x .25" wall CHANNEL RAILS | .75"sq x .125" wall PICKETS | 3.5' - 7' NOMINAL OPENINGS

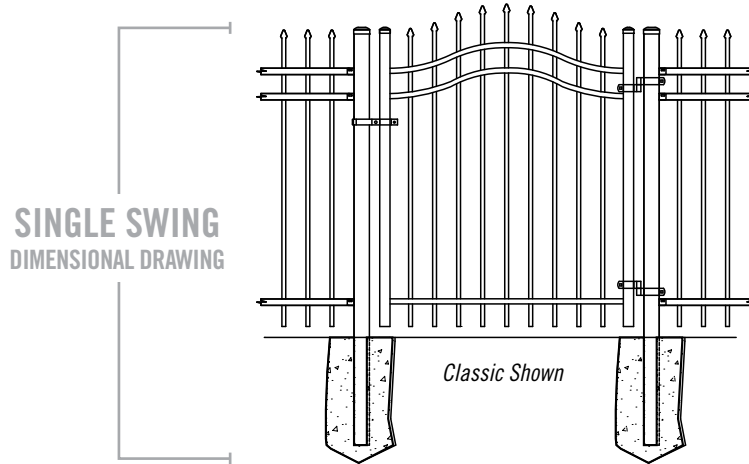

SINGLE SWING HARDWARE KITS & POST INTERSPACES

OPENING	LEAF WIDTH*	TCSGK TRU-CLOSE HINGE KIT			EGBS25 / EGBS3 BOLT-ON HARDWARE KITS			EGBS25A / EGBS3A AMERISTAR LOCK / BOLT-ON HINGE KIT		
		HC	LC	P _s	HC	LC	P _s	HC	LC	P _s
3.5'	40"	.75"	.75"	41.5"	2"	2"	44"	2"	.625"	42.625"
4'	49.5"	.75"	.75"	51"	2"	2"	53.5"	2"	.625"	52.125"
5'	58.75"	.75"	.75"	60.25"	2"	2"	62.75"	2"	.625"	61.375"
6'	68"	.75"	.75"	69.5"	2"	2"	72"	2"	.625"	70.625"
7'	86.75"	.75"	.75"	88.25"	2"	2"	90.75"	2"	.625"	89.375"

W = width* | HC = hinge clearance | LC = latch clearance | P_s = gate post spacing**
 * From outside to outside | ** From inside to inside

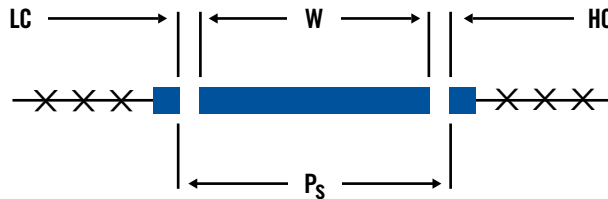

Effective: 01/06/15

ECHELON PLUS® | 3-RAIL SINGLE SWING ARCHED GATES

STANDARD BOTTOM | GATE HARDWARE NOT INCLUDED

	OPENING	LEAF WIDTH	ITEM NUMBER	PICKET QTY	WEIGHT	STOCKING
4' HEIGHT	3½'	40"	A☒☒348-42A	7	42 lbs	☉
	4'	49.5"	A☒☒348-48A	9	48 lbs	☉
	5'	58.75"	A☒☒348-60A	11	55 lbs	☉
	6'	68"	A☒☒348-72A	13	62 lbs	☉
	7'	86.75"	A☒☒348-84A	17	75 lbs	☉
5' HEIGHT	3½'	40"	A☒☒360-42A	7	49 lbs	☉
	4'	49.5"	A☒☒360-48A	9	57 lbs	☉
	5'	58.75"	A☒☒360-60A	11	65 lbs	☉
	6'	68"	A☒☒360-72A	13	72 lbs	☉
	7'	86.75"	A☒☒360-84A	17	88 lbs	☉

☒ = FENCE STYLES AVAILABLE | **C** = Classic **M** = Majestic **G** = Genesis **W** = Warrior **R** = Conqueror
 ☒ = COLOR OPTIONS AVAILABLE | **B** = Black **N** = Bronze **W** = White
 ☉ = NON-STOCKED PRODUCT
 For details, see Ameristar's Sales Policy in the catalog guide.

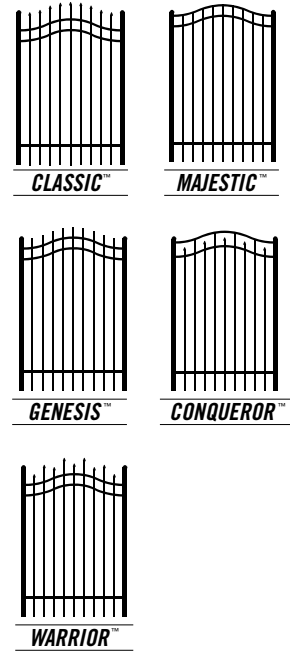

ECHELON PLUS® | 3-RAIL SINGLE SWING ARCHED GATES WITH RINGS

STANDARD BOTTOM | GATE HARDWARE NOT INCLUDED

	OPENING	LEAF WIDTH	ITEM NUMBER	PICKET QTY	WEIGHT	STOCKING
4' HEIGHT	3.5'	40"	A☒☒348-42AR	7	44 lbs	☉
	4'	49.5"	A☒☒348-48AR	9	50 lbs	☉
	5'	58.75"	A☒☒348-60AR	11	58 lbs	☉
	6'	68"	A☒☒348-72AR	13	65 lbs	☉
	7'	86.75"	A☒☒348-84AR	17	79 lbs	☉
5' HEIGHT	3.5'	40"	A☒☒360-42AR	7	51 lbs	☉
	4'	49.5"	A☒☒360-48AR	9	59 lbs	☉
	5'	58.75"	A☒☒360-60AR	11	68 lbs	☉
	6'	68"	A☒☒360-72AR	13	75 lbs	☉
	7'	86.75"	A☒☒360-84AR	17	92 lbs	☉

☒ = FENCE STYLES AVAILABLE | **C** = Classic **M** = Majestic **G** = Genesis **W** = Warrior
 ☒ = COLOR OPTIONS AVAILABLE | **B** = Black **N** = Bronze **W** = White
 ☉ = NON-STOCKED PRODUCT
 For details, see Ameristar's Sales Policy in the catalog guide.

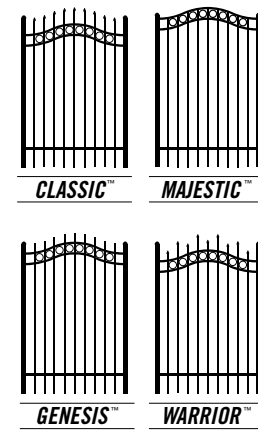

Effective: 01/06/15

ECHELON PLUS® | 4-RAIL SINGLE SWING ARCHED GATES

STANDARD BOTTOM | GATE HARDWARE NOT INCLUDED

OPENING	LEAF WIDTH	ITEM NUMBER	PICKET QTY	WEIGHT	STOCKING
3½'	40"	A☒☒472-42A	7	57 lbs	☉
4'	49.5"	A☒☒472-48A	9	66 lbs	☉
5'	58.75"	A☒☒472-60A	11	74 lbs	☉
6'	68"	A☒☒472-72A	13	83 lbs	☉
7'	86.75"	A☒☒472-84A	17	101 lbs	☉

6'
HEIGHT

☒ = FENCE STYLES AVAILABLE | **C** = Classic **M** = Majestic **G** = Genesis **W** = Warrior **R** = Conqueror
 ☒ = COLOR OPTIONS AVAILABLE | **B** = Black **N** = Bronze **W** = White
 ☉ = NON-STOCKED PRODUCT
 For details, see Ameristar's Sales Policy in the catalog guide.



CLASSIC™

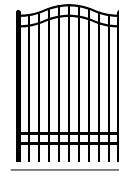

MAJESTIC™

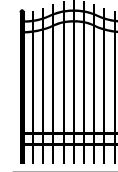

GENESIS™



CONQUEROR™

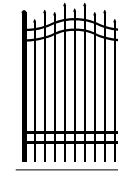

WARRIOR™

ECHELON PLUS® | 4-RAIL SINGLE SWING ARCHED GATES WITH RINGS

STANDARD BOTTOM | GATE HARDWARE NOT INCLUDED

OPENING	LEAF WIDTH	ITEM NUMBER	PICKET QTY	WEIGHT	STOCKING
3½'	40"	A☒☒472-42AR	7	59 lbs	☉
4'	49.5"	A☒☒472-48AR	9	68 lbs	☉
5'	58.75"	A☒☒472-60AR	11	77 lbs	☉
6'	68"	A☒☒472-72AR	13	86 lbs	☉
7'	86.75"	A☒☒472-84AR	17	105 lbs	☉

6'
HEIGHT

☒ = FENCE STYLES AVAILABLE | **C** = Classic **M** = Majestic **G** = Genesis **W** = Warrior
 ☒ = COLOR OPTIONS AVAILABLE | **B** = Black **N** = Bronze **W** = White
 ☉ = NON-STOCKED PRODUCT
 For details, see Ameristar's Sales Policy in the catalog guide.



CLASSIC™

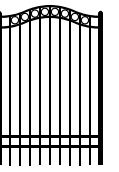

MAJESTIC™



GENESIS™



WARRIOR™

Effective: 01/06/15

ECHELON PLUS® | 2-RAIL SINGLE SWING ARCHED POOL GATES

FLUSH BOTTOM | GATE HARDWARE NOT INCLUDED

OPENING	LEAF WIDTH	ITEM NUMBER	PICKET QTY	WEIGHT	STOCKING
4' HEIGHT	3½' POOL	AM ⊗ 248-42A	7	38 lbs	⊙
	4' POOL	AM ⊗ 248-48A	9	44 lbs	⊙
	5' POOL	AM ⊗ 248-60A	11	50 lbs	⊙
	6' POOL	AM ⊗ 248-72A	13	56 lbs	⊙
	7' POOL	AM ⊗ 248-84A	17	68 lbs	⊙

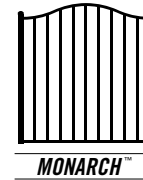

⊗ = FENCE STYLES AVAILABLE | M = Monarch
 ⊗ = COLOR OPTIONS AVAILABLE | B = Black N = Bronze W = White
 ⊙ = NON-STOCKED PRODUCT
 For details, see Ameristar's Sales Policy in the catalog guide.

ECHELON PLUS® | 3-RAIL SINGLE SWING ARCHED POOL GATES

FLUSH BOTTOM | GATE HARDWARE NOT INCLUDED

OPENING	LEAF WIDTH	ITEM NUMBER	PICKET QTY	WEIGHT	STOCKING
4½' HEIGHT	3½' POOL	A ⊗ ⊗ 354-42A	7	45 lbs	⊙
	4' POOL	A ⊗ ⊗ 354-48A	9	53 lbs	⊙
	5' POOL	A ⊗ ⊗ 354-60A	11	60 lbs	⊙
	6' POOL	A ⊗ ⊗ 354-72A	13	67 lbs	⊙
	7' POOL	A ⊗ ⊗ 354-84A	17	81 lbs	⊙
3½' POOL	40"	A ⊗ ⊗ 354-42AR	7	45 lbs	⊙
4' POOL	49½"	A ⊗ ⊗ 354-48AR	9	53 lbs	⊙
5' POOL	58¾"	A ⊗ ⊗ 354-60AR	11	60 lbs	⊙
6' POOL	68"	A ⊗ ⊗ 354-72AR	13	67 lbs	⊙
7' POOL	86¾"	A ⊗ ⊗ 354-84AR	17	81 lbs	⊙

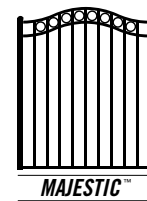
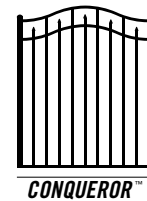
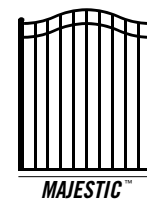

⊗ = FENCE STYLES AVAILABLE | M = Majestic R = Conqueror
 ⊗ = COLOR OPTIONS AVAILABLE | B = Black N = Bronze W = White
 ⊙ = NON-STOCKED PRODUCT
 For details, see Ameristar's Sales Policy in the catalog guide.

Effective: 01/06/15

Effective: 01/06/15

TO PLACE YOUR ORDER CALL 888-333-3422 | VISIT AMERISTARFENCE.COM

AMERISTAR®
ASSA ABLOY

Effective: 01/06/15