

PVC Fencing

# RANCH RAIL FENCE AND GATE

INSTALLATION INSTRUCTIONS

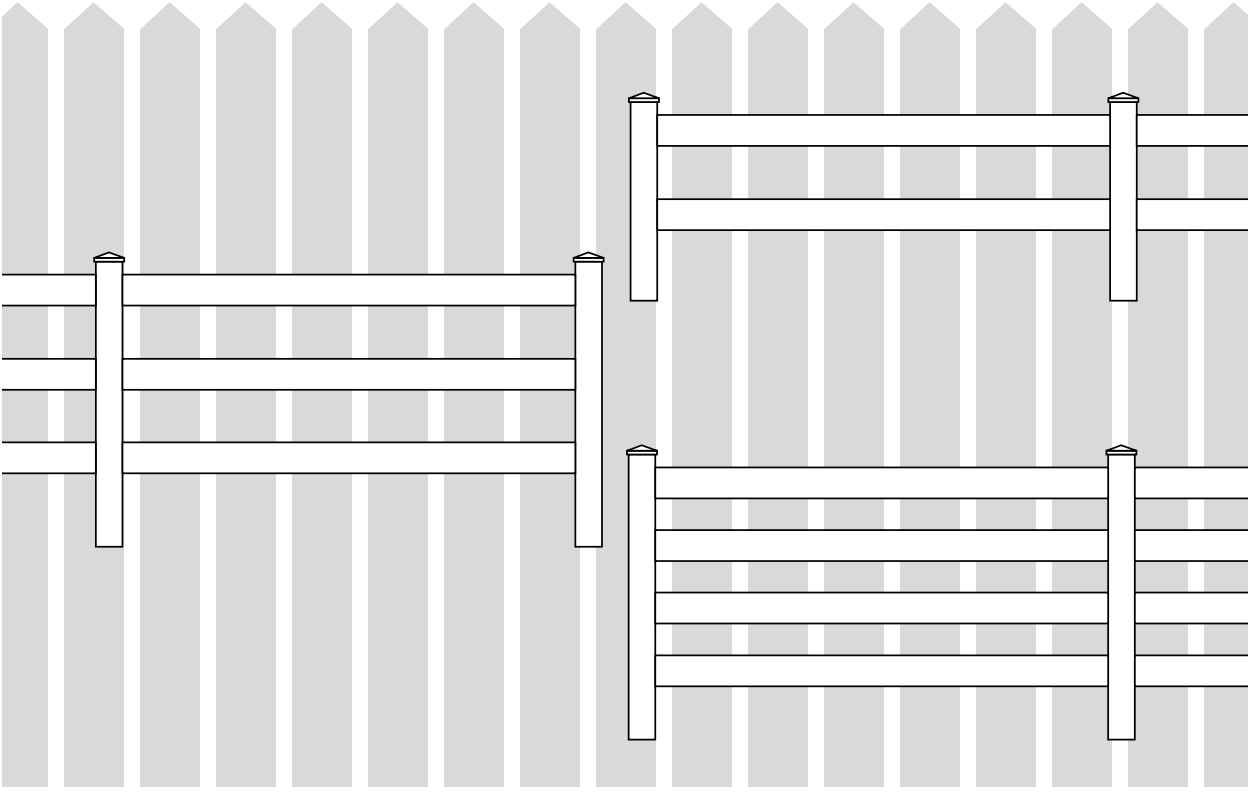

*First Because They Last.™*

**BEFORE YOU START, IT'S IMPORTANT TO CHECK . . .**

- . . . That fence footings do not exceed legally established property lines. If uncertain, refer to real estate agent's line plot or consult a professional surveyor.
- . . . Local codes for specifications regarding frontage locations, allowable fence heights, etc. A permit may be required.
- . . . With local utility companies for locations of underground cables or pipelines.

## RANCH RAIL FENCE

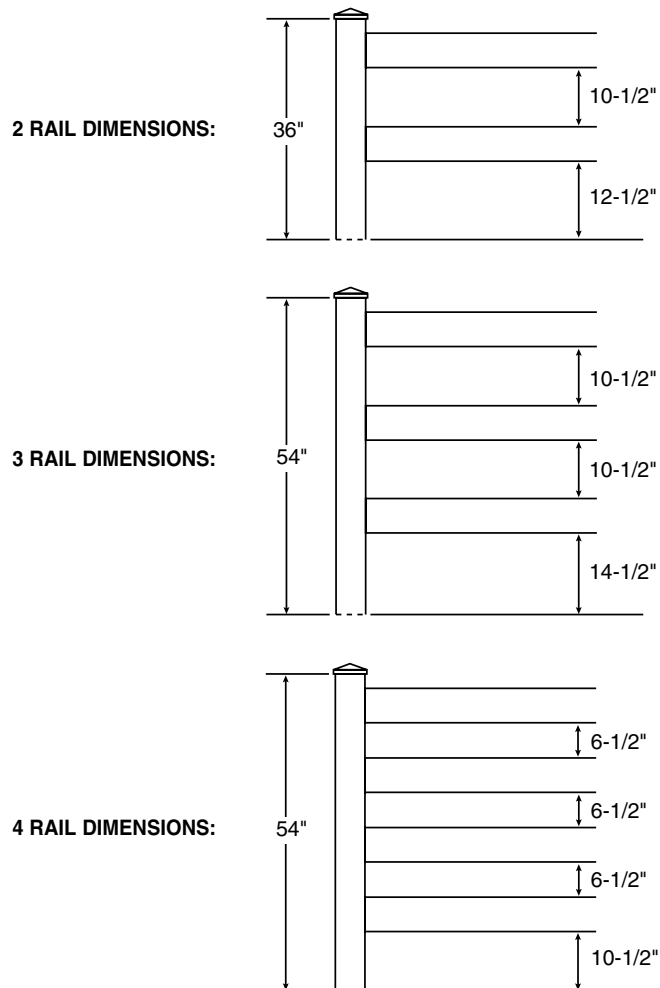

**1 PREPARE FENCE LAYOUT**

**NOTE:** Standard fence sections and gates are designed for level terrain. Significant slopes in the terrain will necessitate modifications to panel kits, gate kits and posts.

**GENERAL INFORMATION:**

Read this instruction sheet completely before starting work.

During panel/gate assembly, work on a soft, non-abrasive surface to avoid scratching the PVC.

When cutting PVC components with a power saw, use a fine-toothed blade (plywood blade, finishing blade, etc.).

Plan ahead when working with PVC glue. It dries very fast, requiring speed and precision.

Laying out the fence is the critical first step toward ensuring a quality installation.

**STEP 1**

Locate the boundary lines to your property.

**STEP 2**

Drive stakes into the ground along the property line and stretch a string between each stake. *Be sure to extend the string about 24" beyond the property line (Fig. 1).*

*It is recommended that all posts be set approximately 6" inside of the property line so that concrete footings do not encroach onto the adjoining property.*

**STEP 3**

Mark the location of each terminal post with a stake (corner, end and gate posts are called **terminal** posts).

*When determining the position of the gate posts, refer to Ranch Rail Gate section for actual gate opening.*

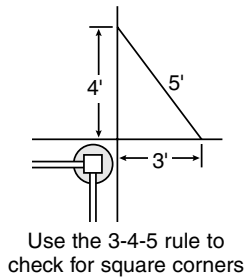
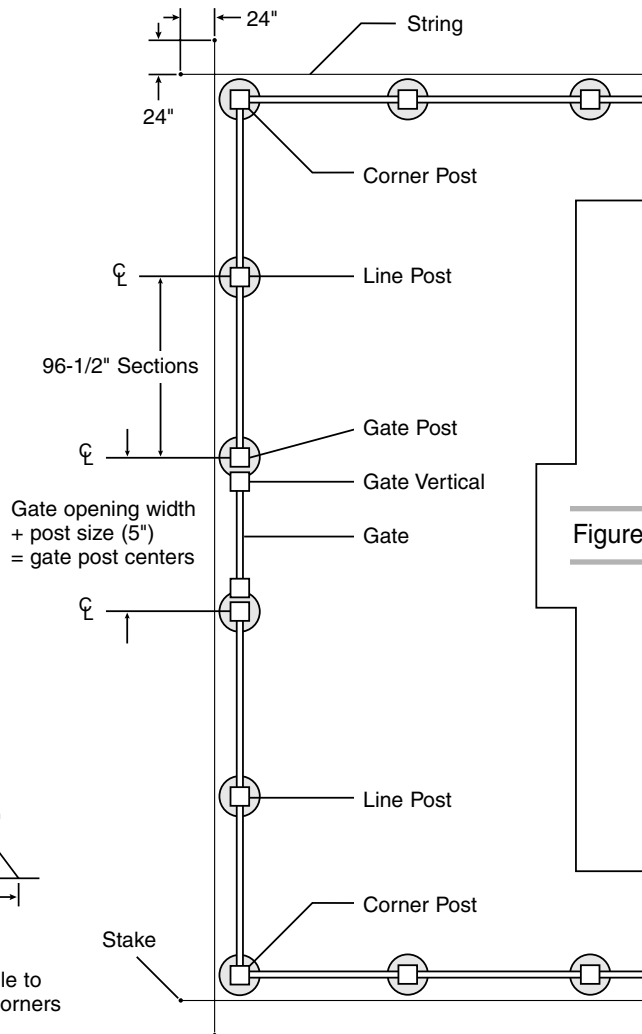

**2** SETTING TERMINAL POSTS

Although post depth and hole diameter will be determined by local weather and soil conditions, holes for terminal posts and line posts are typically dug 10" in diameter and 30" deep with sloped sides (Fig. 2A-C).

**STEP 1**

Dig all terminal post holes.

**SET ALL TERMINAL POSTS IN CONCRETE.**

**STEP 2**

Position the post in the hole. The posts should be centered in the hole and must be square with the fence line so that when the rails are inserted into the posts they will parallel the string line. Check the post on two adjacent sides with a carpenter's level and adjust as necessary to make sure it is plumb. The fence height above grade is determined at this time as well (Fig. 2A-C).

**STEP 3**

Pour concrete around post, fill to 2" below ground level. Once the concrete is completely dry, fill the balance of the hole with dirt.

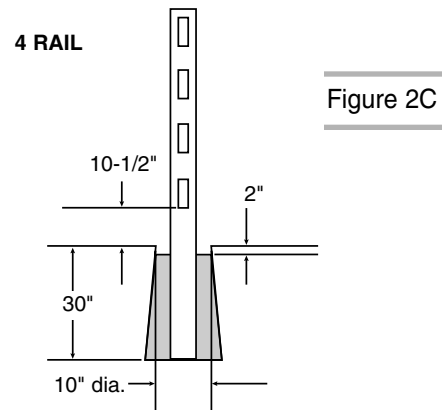
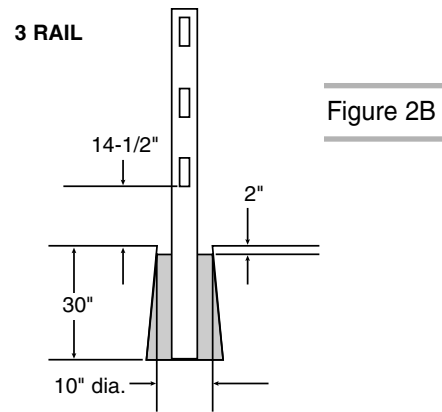
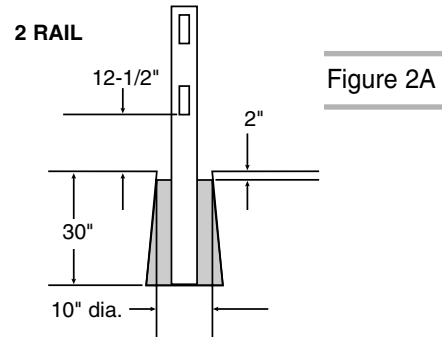

**3 LOCATING AND SETTING LINE POSTS**

**STEP 1**

After the terminal post footings have hardened enough for the posts to remain stable, stake and stretch a string line taut across the tops of the posts to mark the desired height of the line posts (Fig. 3).

**STEP 2**

Working along the string line, stake out the positions of all line posts.

**STEP 3**

Dig all line post holes.

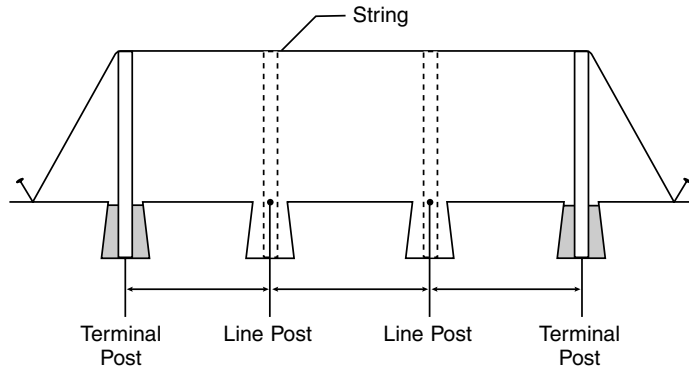

Figure 3

**STEP 4**

Set all line posts as described in section 2, 'SETTING TERMINAL POSTS', Step 1 and Step 2.

**4 INSTALLING RAILS**

**Note:** The design of the fencing system must take into consideration the expansion or contraction of the profiles caused by temperature changes. A minimum distance of 1/2" between rails is required to allow for expansion. A minimum distance of 1/4" between notches or clips and the inside wall of the post is required to allow for contraction.

**STEP 1**

If using the Legend Ranch Rail clip, drill all rails at this time. Holes for the Ranch-Rail clip should be 1/2" in diameter, drilled in the center of the rail, 3/4" in from the end of the rail to the center of the hole. Drill one hole on each side of rail and repeat at each end of rail (Fig. 4).

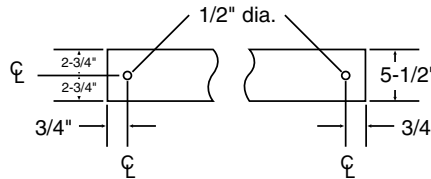

Figure 4

**STEP 2**

Once the concrete around the posts is completely dry, slide 16' rails through the holes in the posts (Fig. 5).

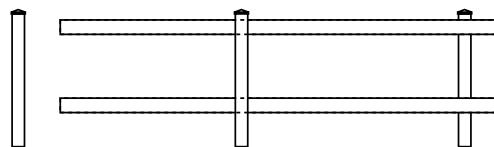

Figure 5

**4** **INSTALLING RAILS (continued)**

**STEP 3**

Insert a Ranch-Rail clip in each end of rail (Fig. 6) and secure the rail inside of the posts at each end as shown.

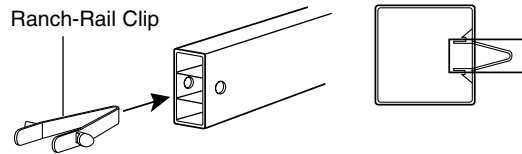

Figure 6

**STEP 4**

If using the Legend® notching tool instead of Ranch-Rail clips, notch both ends of rail (Fig. 7) and secure the rail inside of the posts at each end as shown.

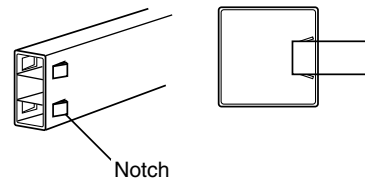

Figure 7

**STEP 5**

If the rail is going into a post which will be filled with concrete (refer to section 5, 'FILLING POSTS WITH RE-BAR & CONCRETE'), seal the end of the rail with duct tape to prevent concrete from flowing into it (Fig. 8).

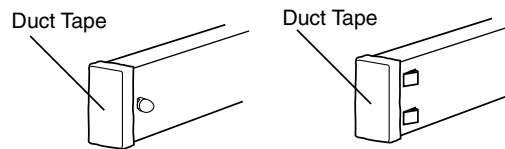

Figure 8

**STEP 6**

Cut one 16' rail in half. Insert one 8' rail into the center holes in the first two posts. Secure the rail as detailed in Steps 2–5. This creates staggered joints that will continue on the full length of the fence. Use the other 8' rail at the opposite end of the fence (Fig. 9).

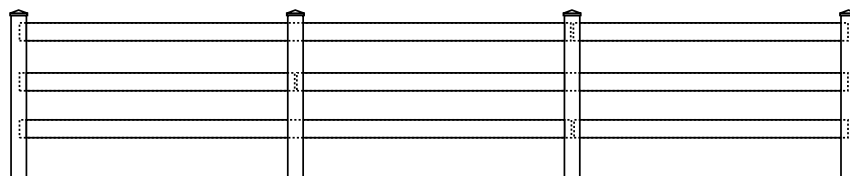

Figure 9

**5 FILLING POSTS WITH RE-BAR & CONCRETE**

Gate posts\* on 2-rail fences should be filled to within 2" of the top of the posts with concrete and rebar. Corner posts and end posts should be filled half-way with concrete only. Line posts do not need to be filled.

Gate posts\*, corner posts and end posts on 3-rail fences should be filled to within 2" of the top of the posts with concrete and rebar. Line posts do not need to be filled.

Gate posts\*, corner posts and end posts on 4-rail fences should be filled to within two inches of the top of the posts with concrete and rebar. Line posts should be filled half-way with concrete only.

\* Make sure the gate hardware is installed before filling gate posts with concrete.

**STEP 1**

*NOTE: If re-bar is not being used, proceed to step 2.*

Cut four pieces of #4 re-bar 4" shorter than the post length. Drop two pieces into each post at opposing corners (Fig. 10).

**STEP 2**

Using a large funnel, fill the posts with concrete (Fig. 11). Tap lightly on the sides of the post to help void air pockets in the concrete.

**STEP 3**

Clean up excess concrete with water before it dries.

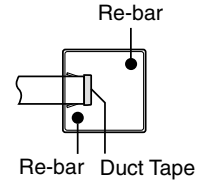

Figure 10

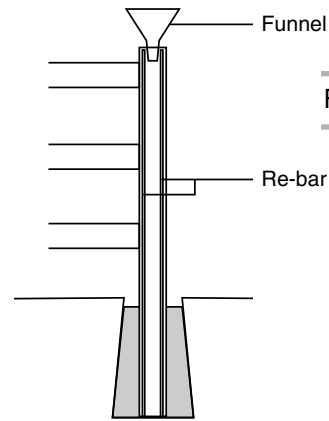

Figure 11

**6 INSTALLING POST CAPS**

**Note: Do not install post caps on gate posts until gate installation is complete.**

**EXTERNAL CAPS** (slide over the post)

**STEP 1 (Option A)**

Apply PVC glue to the inside of the cap and press completely onto the top of the post (Fig. 12). Press firmly to ensure that the cap is on as far as it will go.

**INTERNAL CAPS** (slide into the post)

**STEP 1 (Option B)**

Apply PVC glue to the inside of the post and slide the cap completely inside (Fig. 13). Press firmly to ensure that the cap is on as far as it will go.

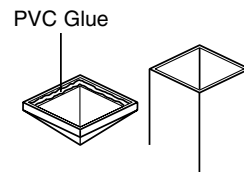

Figure 12

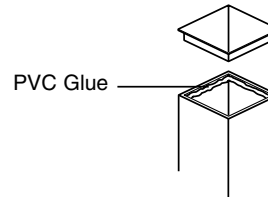

Figure 13

## RANCH RAIL GATE

### PARTS LIST

Available in 2-rail, 3-rail and 4-rail. Gate openings are 51", 75", 99" and 123".

#### EACH 4' WIDE RANCH RAIL GATE INCLUDES:

- A. 1-1/2" x 5 1/2" Rails (\*)
- B. 5" Sq. Gate Verticals w/Pockets (2)
- C. 5" Sq. Pyramid Post Caps (2)
- D. V-Channel Brace (2)
- E. Heavy Duty Hinges (2)
- F. Heavy Duty Latch (1)
- G. #8 x 3/4" Stainless Steel Screws (\*\*)  
Screw Cap Washers (\*\*)  
Screw Caps (\*\*)
- 1.5 Oz. Tube PVC Glue (1) - Not shown

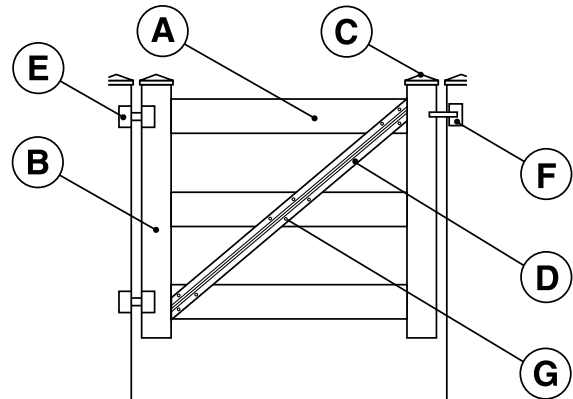

\* 2-rail = 2, 3-rail = 3, 4-rail = 4

\*\* 2-rail = 12, 3-rail = 20, 3-rail = 28

#### EACH 6', 8' AND 10' RANCH RAIL GATE INCLUDES:

- A. 1-1/2" X 5 1/2" Rails (\*)
- B. 5" Sq. Gate Verticals w/Pockets (2)
- C. 5" Sq. Gate Vertical w/o Pockets (1)
- D. 5" Sq. Pyramid Post Caps (3)
- E. V-Channel Brace (4)
- F. Heavy Duty Hinges (2)
- G. Heavy Duty Latch (1)
- H. #8 x 3/4" Stainless Steel Screws (\*\*)  
Screw Cap Washers (\*\*\*)  
Screw Caps (\*\*\*)
- Center Vertical Insert Bracket (2) – Not Shown
- 1.5 Oz. Tube PVC Glue (1) – Not shown

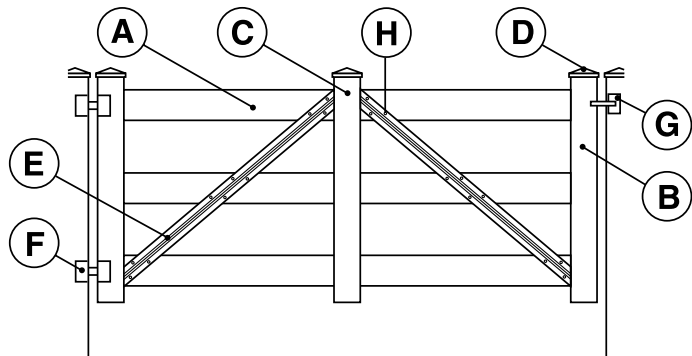

\* 2-rail = 2, 3-rail = 3 and 4-rail = 4

\*\* 2-rail = 26, 3-rail = 42 and 4-rail = 58

\*\*\* 2-rail = 24, 3-rail = 40 and 4-rail = 56

**1 DETERMINE GATE WIDTH**

Standard 4', 6', 8' and 10' wide gates are made to fit openings measuring 51", 75", 99" and 123" respectively between the posts. The actual gate width will be 3" less than the opening between posts (Fig. 14).

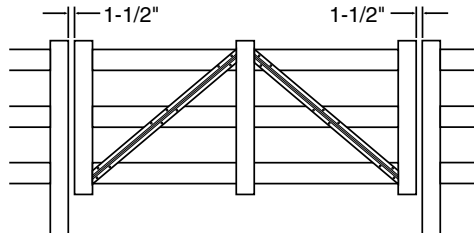

Figure 14

*If your gate opening is narrower than standard, use the following information to modify your gate kit:*

**STEP 1**

Cut the horizontal rails 5-1/2" shorter than the opening width between the posts (Fig. 15).

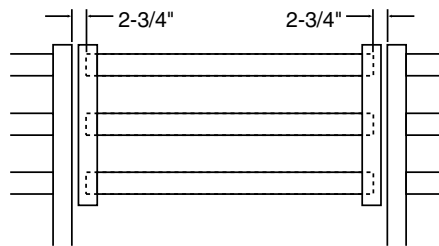

Figure 15

**2 GATE ASSEMBLY**

**STEP 1**

Starting with just one gate vertical, apply PVC glue liberally to the inside of one gate pocket and slide a rail completely inside of the gate pocket. Repeat this step for each rail.

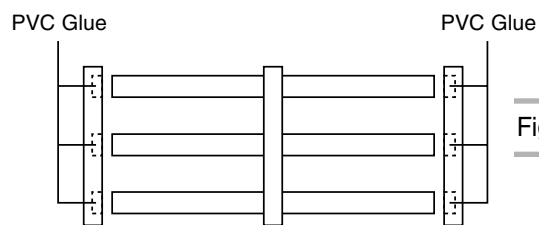

Figure 16

**STEP 2**

Slide the center gate vertical onto the rails and move it toward the center of the gate. Leave it loose for now.

**STEP 3**

Quickly apply PVC glue to the inside of all three gate pockets on the remaining gate vertical. Quickly slide the gate vertical completely onto the rails (Fig. 16).

**STEP 4**

Position the center gate vertical in the center of the gate.

**STEP 5**

Apply PVC glue to the inside of the center vertical bracket and slide the bracket into the top of the gate center vertical and completely onto the top rail. Drill a pilot hole and screw the bracket to the top rail using #8 X 3/4" stainless steel screw (Fig. 17).

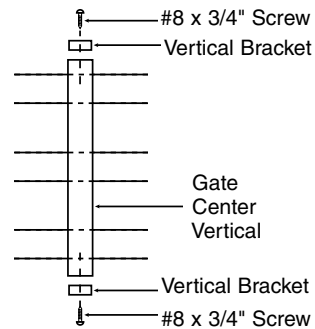

Figure 17

**STEP 6**

Repeat Step 5 at the bottom of the gate.

**2 GATE ASSEMBLY (continued)**

**STEP 7**

Check to make sure that the gate is square (the distance between opposite corners should be equal) (Fig. 18).

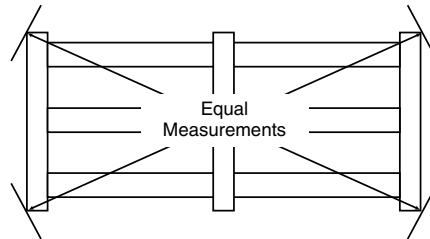

Figure 18

**3 INSTALLING DIAGONAL BRACE**

**STEP 1**

Starting on one side (front or back) of the gate, position the gate braces on the gate, between the verticals and against the rails (Fig. 19).

If the gate kit has been modified mark the correct length and angle and cut the braces.

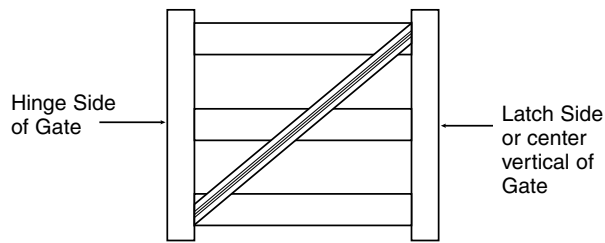

Figure 19

**STEP 2**

Hold the brace in position and carefully drill through the brace and one wall of the rail (Fig. 20).

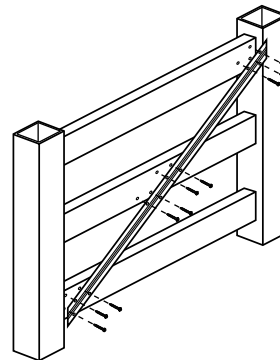

Figure 20

**STEP 3**

Secure the brace with #8 X 3/4" stainless steel screws, screw cap washers and screw caps (Fig. 21).

**Repeat Steps 1–3 on the opposite side of the gate.**

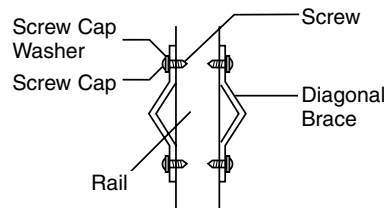

Figure 21

**4**

**INSTALLING GATE VERTICAL CAPS**

**STEP 1**

Install the caps on the gate verticals as described in the Ranch Rail Fence section 6, 'INSTALLING POST CAPS'.

**5**

**HANGING THE GATE**

**STEP 1**

Position the gate in the gate opening and block-up the gate as necessary to line up the horizontal gate rails with those of the fence (Fig. 22). Attach hinges and latch to gate and posts per the installation instructions packaged with the hardware.

**STEP 2**

Fill gate posts with re-bar and concrete as described in Ranch Rail Fence section 5, 'FILLING POSTS WITH RE-BAR & CONCRETE'.

**STEP 3**

Install gate post caps (refer to Ranch Rail Fence section 6, 'INSTALLING POST CAPS').

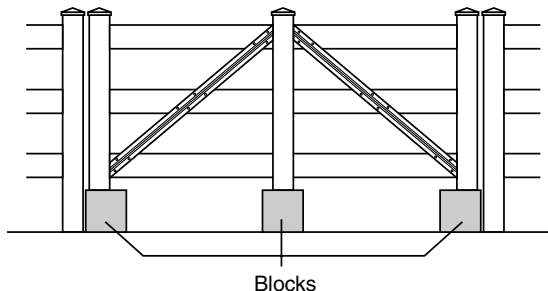

Figure 22

**6**

**CLEAN-UP**

Clean PVC material as necessary with a non-abrasive (or slightly abrasive) mild biodegradable soap and soft plastic scouring pad. Rinse thoroughly with clean water to remove dirt and soap.

For more information, contact our  
Customer Service Department:  
1-888-MH-FENCE (toll-free)  
110 E. La Habra Blvd., La Habra, CA 90631  
e-mail: [info@fenceonline.com](mailto:info@fenceonline.com) • [www.fenceonline.com](http://www.fenceonline.com)

